

SUPAFLEX

PRODUCT

CATALOG

www.supaflex.co.in



Industrial PRODUCTS LINE

| SPIRAL CONDUITS & FITTINGS | CABLE GLANDS & ACCESSORIES | PANEL FANS
| PVC WIRING DUCTS | DIN MOUNTING RAILS | CABLE TIES | LUGS | DRAG CHAIN
| HEAVY DUTY CONNECTORS | PILOT LIGHT & PUSH BUTTONS | INDUSTRIAL SWITCHES

A trusted **BRAND** for industrial needs

TÜV CE  **RoHS**

TACFLEX POLYAMIDE SPIRAL CONDUITS

TECHNICAL DETAILS

Material	: Polyamide PA6 V2
Color	: Grey (RAL7031) black (RAL9005) * Orange or any other color available on request
Temperature range	: -40 °C + 120 °C
Flammability class	: UL94 V2

Properties

High fatigue life
 High impact strength
 Halogen free
 Self extinguishing
 High abrasion resistance
 High UV resistance (black)
 Full-shrink packing

PLASTIC SPIRAL CONDUITS

PA 6

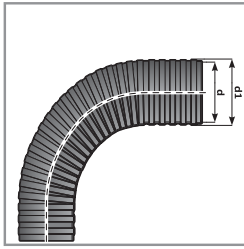
POLYAMİD SİRAL BORU

Hammaddesi	: Polyamid PA6 V2
Renk	: RAL 7031 (Gri) : RAL 9005 (Siyah)
Çalışma sıcaklığı	: -40 °C + 120 °C
Kullanım alanları	: Mekanik ve ekipman cihaz bağlantılarında makine, matbaa, otomotiv, lokomotif, tramvay, gemi otomatik makineleri, endüstriyel tesis montajlarında, aydınlatma ve elektrik pano montajlarında kullanılmaktadır.

PA6 SPIRAL CONDUITS
PRODUCT RANGE OVERVIEW

Nominal Diameter	Gray Code	Black Code	d	d1	Roll Length mt.
	■ RAL 7031	■ RAL 9005	Ø mm.	Ø mm.	
7	OGPA 7	OSPA 7	6,5	10	100
8,5	OGPA 8,5	OSPA 8,5	8,5	12	100
9	OGPA 9	OSPA 9	10	13	100
11	OGPA 11	OSPA 11	12	15,8	50
13,5	OGPA 13,5	OSPA 13,5	14,2	18,4	50
16	OGPA 16	OSPA 16	16,5	21,2	50
21	OGPA 21	OSPA 21	23,5	28,4	50
29	OGPA 29	OSPA 29	29	34,5	25
36	OGPA 36	OSPA 36	36	42,5	25
48	OGPA 48	OSPA 48	48	54,5	25

Halogen free



TACFLEX POLYAMIDE CONDUIT GLANDS - 90° ELBOW
TECHNICAL DETAILS

Material	: Polyamide PA6 V2
Connection thread	: Metric (EN 60423)/PG (DIN 40430)
Color	: Grey (RAL7031) Black (RAL9005)
Temperature range	: -30 °C +80 °C

Properties

UV resistance (black)
 Easy to assemble
 Halogen free
 Apply with either PA or PP conduits

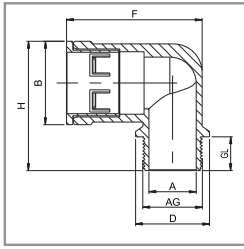
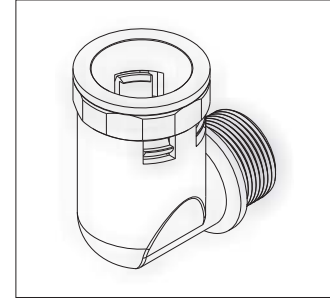
POLYAMIDE CONDUITS GLANDS 90° ELBOW TYPE

90° DİRSEK SİRİAL BORU RAKORU

Hammaddesi	: Polyamid
Renk	: RAL 7031 (Gri) RAL 9005 (Siyah)
Bağlantı dişi M	: EN 60423
Bağlantı dişi PG	: DIN 40430
Çalışma sıcaklığı	: -30 °C + 80 °C

METRIC/PG CONDUIT GLANDS

AG mm.	Gray Code ■ RAL 7031	Black Code ■ RAL 7031	Spiral Dismeter mm.	H mm.	GL mm.	A mm.	B mm.	B mm.	B mm.
M 12 x 1,5	ODDG10-M12	ODDB10-M12	6,5 x 10	36,3	11	8,2	18,7	17	35,7
M 12 x 1,5	ODDG12-M12	ODDB12-M12	8,5 x 12	37,3	11	8,2	20,7	17	35,7
M 16 x 1,5	ODDG13-M16	ODDB13-M16	10 x 13	37,3	11	10,8	21,7	20	38,5
M 16 x 1,5	ODDG15-M16	ODDB15-M16	12 x 15,8	41	11	10,9	26	23	43,8
M 20 x 1,5	ODDG18-M20	ODDB18-M20	14,2 x 18,4	44	11	14,7	28	26	46
M 20 x 1,5	ODDG21-M20	ODDB21-M20	16,5 x 21,2	51,5	13	15,2	32	29	51
M 25 x 1,5	ODDG28-M25	ODDB28-M25	23 x 28,4	61,2	16	18,7	39,5	35	64,3
M 32 x 1,5	ODDG34-M32	ODDB34-M32	29 x 34,5	69,32	16	25,2	46,5	43	70,9
M 40 x 1,5	ODDG42-M40	ODDB42-M40	36 x 42,5	78,2	16	32,7	55,5	54	88,6
M 63 x 1,5	ODDG54-M63	ODDB54-M63	48 x 54,5	91,2	16	55,2	67,5	69	95
PG 7	ODDG10-PG 7	ODDB10-PG 7	6,5 x 10	36,3	11	8,2	18,7	17	35,7
PG 7	ODDG12-PG 7	ODDB12-PG 7	8,5 x 12	37,3	11	8,2	20,7	17	35,7
PG 9	ODDG13-PG 9	ODDB13-PG 9	10 x 13	37,3	11	10,3	21,7	20	38,5
PG 11	ODDG15-PG 11	ODDB15-PG 11	12 x 15,8	41	11	13,3	26	23	43,8
PG 13,5	ODDG18-PG 13,5	ODDB18-PG 13,5	14,2 x 18,4	44	11	15,3	28	26	46
PG 16	ODDG21-PG 16	ODDB21-PG 16	16,5 x 21,2	51,5	13	16,6	32	29	51
PG 21	ODDG28-PG 21	ODDB28-PG 21	23 x 28,4	61,2	16	22,4	39,5	35	64,3
PG 29	ODDG34-PG 29	ODDB34-PG 29	29 x 34,5	69,32	16	31,7	46,5	43	70,9
PG 36	ODDG42-PG 36	ODDB42-PG 36	36 x 42,5	78,2	16	40,5	55,5	54	88,6
PG 48	ODDG54-PG 48	ODDB54-PG 48	48 x 54,5	91,2	16	51,7	67,5	69	95

PRODUCT RANGE OVERVIEW

Halogen free

TACFLEX METAL FLEXIBLE CONDUITS

TECHNICAL DETAILS

Material : Galvanised steel
 Protection class : IP40
 Temperature range : -100 °C +300 °C

Properties

High impact strength
 Halogen free
 Self extinguishing
 High abrasion resistance
 Full-shrink packing

FLEXIBLE SPIRAL CONDUITS METAL

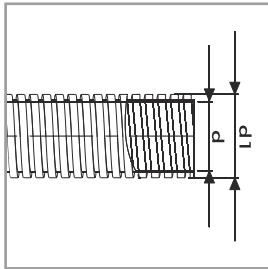
METAL SİRİAL BORULAR

Hammaddesi : Galvaniz & Kalay kaplı sac
 Sürekli ısıya direnci : -100 +300 °C

PRODUCT RANGE OVERVIEW

Code	d mm.	d1 mm.	Roll Length mt.
OCS 7	7,5	10,5	50
OCS 9	9	12	50
OCS 11	11	14	50
OCS 13	13	15,5	50
OCS 14	14	17	50
OCS 16	16	19	50
OCS 18	18	21	50
OCS 21	21	24	50
OCS 26	26	30	25
OCS 29	29	33	25
OCS 32	32	36	25
OCS 35	35	39	25
OCS 37	37	41	25
OCS 40	40	44	25
OCS 42	42	46	25
OCS 45	45	49	25
OCS 51	51	55	25
OCS 55	55	59	25
OCS 60	60	64	25
OCS 63	63	67	25
OCS 75	75	80	25

TACFLEX PVC COATED METAL FLEXIBLE CONDUITS >>>>>>

TECHNICAL DETAILS

Material : Galvanised steel PVC coated
 Color : Black (RAL9005)
 other colors available on request with
 reasonable qty.
 Protection class : IP65
 Temperature range : -15 °C +70 °C

Properties

High fatigue life
 High impact strength
 Self extinguishing
 High UV resistance (black)
 Full-shrink packing

**FLEXIBLE
 SPIRAL CONDUITS
 PVC COATED METAL**

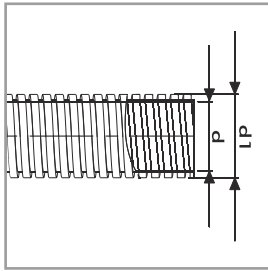

PVC KAPLI METAL SİRİRAL BORULAR

Hammaddesi : Galvaniz & Kalay kaplı sac
 Renk : Gri / Siyah
 Kaplama : PVC
 Sürekli ısıya direnci : -15 °C +70 °C
 Özellik : Alev iletmez
 UV dayanımlı



PRODUCT RANGE OVERVIEW

Code	d mm.	d1 mm.	Roll Length mt.
OPCS 7	7,5	11,5	50
OPCS 9	9	13	50
OPCS 11	11	15	50
OPCS 13	13	16,5	50
OPCS 14	14	18	50
OPCS 16	16	20	50
OPCS 18	18	22	50
OPCS 21	21	25	50
OPCS 26	26	31	25
OPCS 29	29	34	25
OPCS 32	32	37	25
OPCS 35	35	40	25
OPCS 37	37	42	25
OPCS 40	40	45	25
OPCS 42	42	47	25
OPCS 45	45	50	25
OPCS 51	51	56	25
OPCS 55	55	60	25
OPCS 60	60	65	25
OPCS 63	63	68	25
OPCS 75	75	83	25

TACFLEX STAINLESS STEEL FLEXIBLE CONDUITS



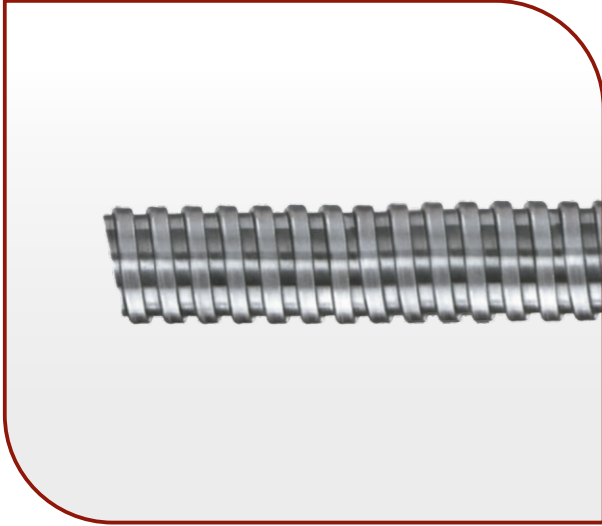

FLEXIBLE SPIRAL CONDUITS

STAINLESS STEEL

TECHNICAL DETAILS

Material : Stainless Steel AISI 304L
 Protection class : IP40
 Temperature range : -100 °C +300 °C

Properties

High impact strength
 High abrasion resistance
 Halogen free
 Low fire hazard
 Self extinguishing
 Full-shrink packing

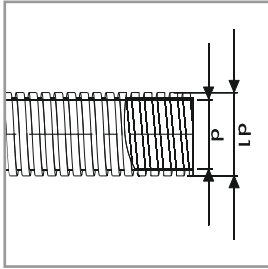

PASLANMAZ ÇELİK SİRİAL BORULAR

Hammaddesi : Paslanmaz çelik AISI 304L
 Sürekli ısıya direnci : -100 °C + 300 °C

PRODUCT RANGE OVERVIEW

Code	Size	d mm.	d1 mm.	Roll Length mt.
OCSS 07	-	7,5	10,5	50
OCSS 09	1/4"	9	12	50
OCSS 11	3/8"	11	14	50
OCSS 13	3/8"	13	15,5	50
OCSS 14	-	14	17	50
OCSS 16	1/2"	16	19	50
OCSS 18	-	18	21	50
OCSS 21	3/4"	21	24	50
OCSS 26	1"	26	30	25
OCSS 29	-	29	33	25
OCSS 32	-	32	36	25
OCSS 35	1 1/4"	35	39	25
OCSS 37	-	37	41	25
OCSS 40	1 1/2"	40	44	25
OCSS 42	-	42	46	25
OCSS 45	-	45	49	25
OCSS 51	2"	51	55	25
OCSS 63	2 1/2"	63	67	25
OCSS 75	3"	75	80	25

TACFLEX LIQUID TIGHT FLEXIBLE CONDUITS

TECHNICAL DETAILS

Material	: Galvanised steel PVC coated liquid tight
Color	: Black (RAL9005) other colors available on request with reasonable qty.
Protection class	: IP66
Temperature range	: -20 °C +105 °C

Properties

High impact strength
Self extinguishing
High UV resistance (black)

FLEXIBLE SPIRAL CONDUITS LIQUID TIGHT

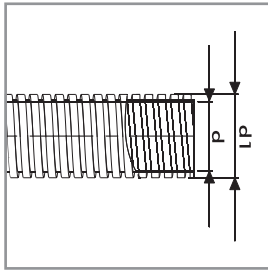
AĞIR HİZMET PVC KAPLI METAL SİRİRAL BORULAR

Hammaddesi	: Galvaniz & Kalay kaplı sac
Kaplama	: PVC
Sürekli ısıya direnci	: -20 °C +105 °C
Özellik	: Alev iletmez UV dayanımlı Ağır hizmet tipi Kırılmayı önleyici mühür ipli
Renk	: Siyah - Gri

PRODUCT RANGE OVERVIEW

Code	Size	d mm.		d1 mm.		Roll Length mt.
LGT 10	1/4"	10,3	10,5	15,5	16	30
LGT 12	3/8"	12,3	12,7	17,5	18	30
LGT 16	1/2"	15,5	16,3	20,8	21,4	30
LGT 21	3/4"	20,9	21,3	26,2	26,5	30
LGT 27	1"	26,5	27	32,7	33,3	30
LGT 35	1 1/4"	35	35,5	41,5	42	15
LGT 40	1 1/2"	40	40,5	47,3	48,2	15
LGT 51	2"	51,5	51,9	59,5	60	15
LGT 63	2 1/2"	63	63,5	72,2	73	7,5
LGT 78	3"	78	78,5	88	88,5	7,5
LGT 91	3 1/2"	88,9	89,9	100,6	101,6	7,5
LGT 102	4"	101,6	102,6	113,3	114,3	7,5



www.supaflex.co.in

Industrial Product Line

Spiral Conduits and Fittings
(Polyamide & Metallic)

Cable Glands
(Polyamide & Metallic)

Wiring Ducts
(Slotted & Un-slotted)

Drag Chains

Industrial Switches
(Limit Switch & Micro Switch)

Heavy Duty Connectors

Panel Fans
(Square & Round Shape)

DIN Rails
(Perforated & Un-perforated)

Lugs
(Insulated & Non-insulated)

Cable Ties

Industrial Push Buttons & Control Boxes
(Illuminated & Non-illuminated)

Download Catalog Here

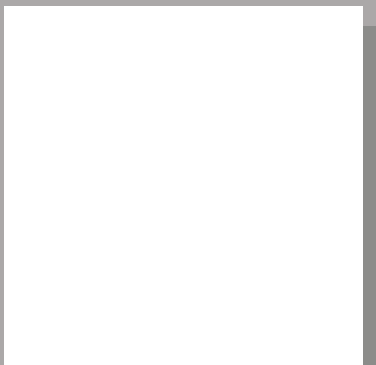

Follow us on



Contact Us

SUPA FLEX PVT. LTD.

Address

Plot No. 8/33, III Floor, R.H.S. Complex,
Industrial Area Kirti Nagar, New Delhi 110015 INDIA

Telephone

+91-11-68888708

Mobile

+91-95999992308 | +91-9599992306-10

E-mail

sales@supaflex.co.in | sales1@supaflex.co.in