



User Guide

AM400-CPU1608TP CPU Module

19010694

A02

1

Thank you for purchasing the AM400-CPU1608TP CPU communication module developed and manufactured independently by Inovance.

AM400 series PLC is a medium-sized PLC developed based on CoDeSys. It fully supports IEC61131-3 programming system, EtherCAT site real-time bus, and cam synchronous movement control. It is provided with unique high-speed I/O interfaces to meet the needs of high-speed applications.

This guide describes the specifications, characteristics and using methods of the AM400-CPU1608TP CPU module. Please read this guide carefully before using to ensure more safe usage. Please refer to the AM400 Series PLC Hardware Manual and the AM400 Series PLC Programming Manual to understand the use of the user program development environment and design method of the user program of the product. You can download the latest materials from [www.inovance.com](http://www.inovance.com)

1. Safety Precautions

Safety information and precautions are identified into two grades: Warning and Caution. Please make sure to operate properly with adequate safety assurance.

- WARNING** Indicates the improper operation which, if not avoided, may cause death or serious injury;
- CAUTION** Indicates the improper operation which, if not avoided, may cause moderate or minor injury, as well as equipment damage.

In some cases, even failure to follow "Cautions" may also lead to serious consequences. Please make sure to follow both warnings and cautions, otherwise, it may cause death or serious injury, as well as product and relevant equipment and system damage.

Please keep this guide well so that it can be read when necessary and forward this guide to the end user.

During control system design

- WARNING**
  - Provide a safety circuit outside the PLC so that the control system can still work safely once external power failure or PLC fault occurs.
  - Add a fuse or circuit breaker because the module may smoke or catch fire due to long-time overcurrent caused by operation above rated current or load short-circuit.

- CAUTION**
  - An emergency stop circuit, a protection circuit, a forward/reverse operation interlocked circuit, and an upper position limit and lower position limit interlocked circuit must be set in the external circuits of the PLC to prevent damage to the machine.
  - To ensure safe operation, for the output signals that may cause critical accidents, please design external protection circuit and safety mechanism.
  - Once PLC CPU detects abnormality in the system, all outputs may be closed; however, when a fault occurs in the controller circuit, the output may not be under control. Therefore, it is necessary to design an appropriate external control circuit to ensure normal operation;
  - If the PLC's output units such as relays or transistors are damaged, the output may fail to switch between ON and OFF states according to the commands;
  - The PLC is designed to be used in indoor electrical environment (overvoltage category II). The power supply must have a system-level lightning protection device, assuring that overvoltage due to lightning shock can't be applied to the PLC's power supply input terminals, signal input terminals and output terminals and so forth, so as to avoid damage to the equipment.

During installation

- WARNING**
  - Installation must be carried out by the specialists who have received the necessary electrical training and understood enough electrical knowledge.
  - Disconnect all external power supplies of the system before module assembly/disassembly and wiring. Failure to do so may result in electric shock, module fault or malfunction.
  - Do not use the PLC where there are dust, oil smoke, conductive dust, corrosive or combustible gases, or exposed to high temperature, condensation, wind & rain, or subject to vibration and impact. Electric shock, fire and malfunction may also result in damage or deterioration to the product.
  - The PLC is an open-type that must be installed in a control cabinet with lock (cabinet housing must satisfy protection of over IP20). Only the personnel who have the necessary electrical training and experience can open the cabinet.

- CAUTION**
  - Prevent metal filings and wire ends from dropping into ventilation holes of the PLC during installation. Failure to comply may result in fire, fault and malfunction.
  - Ensure that there are no foreign matters on ventilation surface. Failure to comply may result in poor ventilation, which may cause fire, fault and malfunction.
  - Ensure the module is connected to the respective connector securely and hook the module firmly. Improper installation may result in malfunction, fault or fall-off.

During wiring

- WARNING**
  - Wiring must be carried out by personnel who have the necessary electrical training and experience.
  - Disconnect all external power supplies of the system before wiring. Failure to comply may result in electric shock, module fault or malfunction.
  - Install the terminal cover attached to the product before power-on or operation after wiring is completed. Failure to comply may result in electric shock.
  - Perform good insulation on terminals so that insulation distance between cables will not reduce after cables are connected to terminals. Failure to comply may result in electric shock or damage to the equipment.

- CAUTION**
  - Prevent dropping metal filings and wire ends drop into ventilation holes of the PLC at wiring. Failure to comply may result in fire, fault and malfunction.
  - The external wiring specification and installation method must comply with local regulations. For details, see the wiring section in this guide.
  - To ensure safety of equipment and operator, use cables with sufficient diameter and connect the cables to ground reliably.
  - Wire the module correctly after making clear of the connector type. Failure to comply may result in module and external equipment fault.
  - Tighten bolts on the terminal block in the specified torque range. If the terminal is not tight, short-circuit, fire or malfunction may be caused. If the terminal is too tight, fall-off, short-circuit, fire or malfunction may be caused.
  - If the connector is used to connect with external equipment, perform correct crimping or welding with the tool specified by manufacturer. If connection is in poor contact, short-circuit, fire or malfunction may be caused.
  - A label on the top of the module is to prevent foreign matters entering the module. Do not remove the label during wiring. Remember to remove it before system operation, facilitating ventilation.
  - Do not bundle control wires, communication wires and power cables together. They must be run with distance of more than 100 mm. Otherwise, noise may result in malfunction.
  - Select shielded cable for high-frequency signal input/output in applications with serious interference so as to enhance system anti-interference ability.

During maintenance & inspection

- WARNING**
  - Maintenance & inspection must be carried out by personnel who have the necessary electrical training and experience.
  - Do not touch the terminals while the power is on. Failure to comply may result in electric shock or malfunction.
  - Disconnect all external power supplies of the system before cleaning the module or re-tightening screws on the terminal block or screws of the connector. Failure to comply may result in electric shock.
  - Disconnect all external power supplies of the system before removing the module or connecting/removing the communication wirings. Failure to comply may result in electric shock or malfunction

- CAUTION**
  - Get acquainted with the guide and ensure safety before online modification, forcible output, and RUN/STOP operation.
  - Disconnect the power supply before installing/removing the extension card.

At disposal

- CAUTION**
  - Treat scrapped module as industrial waste. Dispose the battery according to local laws and regulations.

2. Product Information

Model and Nameplate

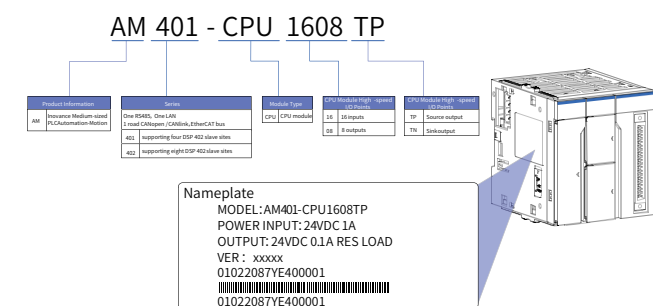

Figure 1 Description of model and nameplate

Model	Classification	Description	Applicable to
AM401-CPU1608TP	CPU module	4 M program storage space; 8 M data storage space; one RS485; One LAN; One road CANopen / CANlink ; Supporting 4-axis motion control; Supporting EtherCAT Built-in 16-input 8-output high-speed I/O Source type output	AM400
AM402-CPU1608TP	CPU module	4 M program storage space; 8 M data storage space; Two RS485; One LAN; One road CANopen / CANlink; supporting 8-axis motion control; Supporting EtherCAT Built-in 16-input 8-output high-speed I/O Source type output	AM400

External Interface

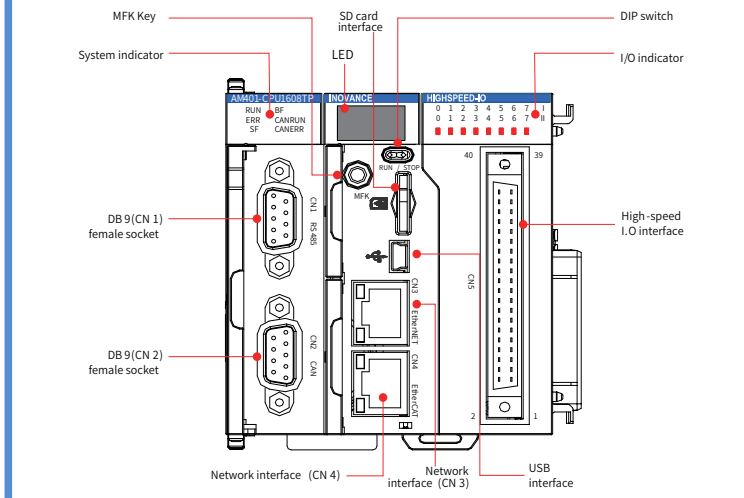

Figure 2 Diagram 1 of the CPU module interface

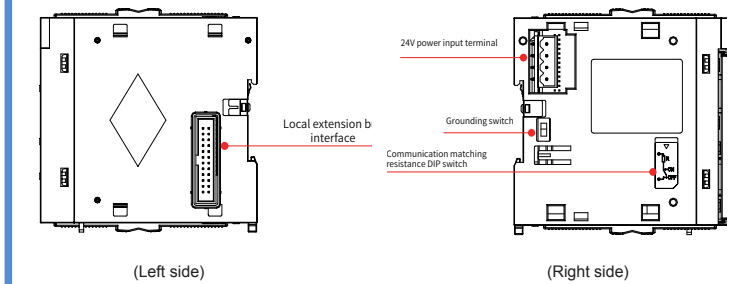
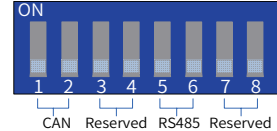

Figure 3 Diagram 2 of the CPU module interface

Interface Name	Function
DB9 (CN1)/(Female socket)	One RS485 interfaces, supporting the MODBUS protocol
DB9 (CN2)/(Female socket)	One road CANopen / CANlink
Ethernet port (CN4)	EtherCAT protocol
Ethernet port (CN3)	1. MODBUS TCP 2. Standard Ethernet function 3. System program debugging 4. User program downloading and debugging (only supporting IPv4)
USB	Program downloading and debugging
High-speed I/O	16-point high-speed input 8-point high-speed output
I/O indicator	16-channel input and 8-channel output signal valid indicator
DIP switch	RUN/STOP DIP switch
SD card interface	Stores user programs and data
MFK key	MFK multi-function key
Indicators	Running indicator RUN CPU module running error indicator ERR System error indicator SF Bus error indicator BF
LED	Displays alarm messages and MFK key response prompt messages
Local expansion bus interface	Can expand up to 8 I/O modules. The actual number and configuration depend on each module's power consumption Not supporting hot plugging
24 V power input terminal	24 VDC voltage input. The AM400 power supply module must be used for power supply
Grounding switch	Connection switch providing the system internal digital ground and housing ground. It is not connected by default. It is used only on special occasions where the system internal digital ground must be used as a reference plane. You shall not operate it without authorization, otherwise system stability is affected.
Communication matching resistance DIP switches	ON indicates matching resistance connection (all OFF by default). 1 and 2 are CAN, 3 and 4 are reserved, 5 and 6 are COM0(RS485), 7 and 8 are reserved:



General Specifications

Item	Specifications
Programming mode	IEC 61131-3 programming languages (LD, FBD, IL, ST, SFC, CFC)
Program execution mode	Complied execution
User program storage space	4 Mbytes
Flash save space upon power failure	512 Kbytes
SD memory card capacity	Up to 32 G general SD card
Program save mode upon power failure	Flash hold/SD card hold optional (No save upon power failure is performed if power failure occurs at power-on time of smaller than 35s)
Internal 5 V power output current	1500 mA (rated value)
Interrupt mode	8-point input interrupt (CPU module high-speed DI), supporting rising edge and falling edge interrupt

Input Specifications

Item	Specifications	
Signal Name	High-speed input (differential or single-ended) (X0-X5)	High-speed input (single-ended) (X6-XF)
	24 V input	Differential input 24 V input
Rated input voltage	24 VDC (-15% to +20%, pulsation within 5%)	24 VDC(-15% to +20%, pulsation within 5%)
Rated input current	7.3 mA (typical) (at 24 VDC)	7.3 mA(typical) (at 24 VDC)
ON current	More than 5 mA	More than 5 mA
OFF current	Less than 1.5 mA	Less than 1.5 mA
Input resistance	3.3 kΩ	3.3 kΩ
Maximum count speed	800 Kpps (two-phase quadruplicated frequency), 200 kHz (single-phase input)	
Worst duty ratio at two-phase input	(40% : 60%) to (60% : 40%)	
Common mode	Two groups of common terminals	One common terminal per 10 points

Output Specifications

Item	Specifications
Signal Name	Output (Y0-Y7)
Output polarity	Source type output (High-side output)
Control circuit voltage	5 VDC to 24 VDC
Rated load current	0.1 A / point, 0.5 A / COM
Maximum voltage drop when the module is turned ON	0.2 V (typical value)
Leakage current when the module is turned OFF	Less than 0.1 mA
Output frequency	200 kHz(You must connect an over 12 mA external equivalent load for 200 kHz output.)
Common mode	One common terminal per 4 points

\*The total extended distance of the high-speed I/O interface extension cable shall be within 3.0 m.  
\*The single-phase pulse duty ratio must be greater than 40% when high-speed input is in phases A and B.

3. Mechanical Design Reference

Dimensions

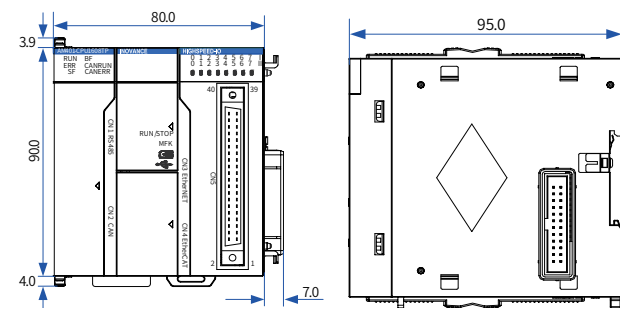

Figure 4 Diagram of CPU module dimensions (unit: mm)

4. Electrical Design Reference

Terminal Arrangement

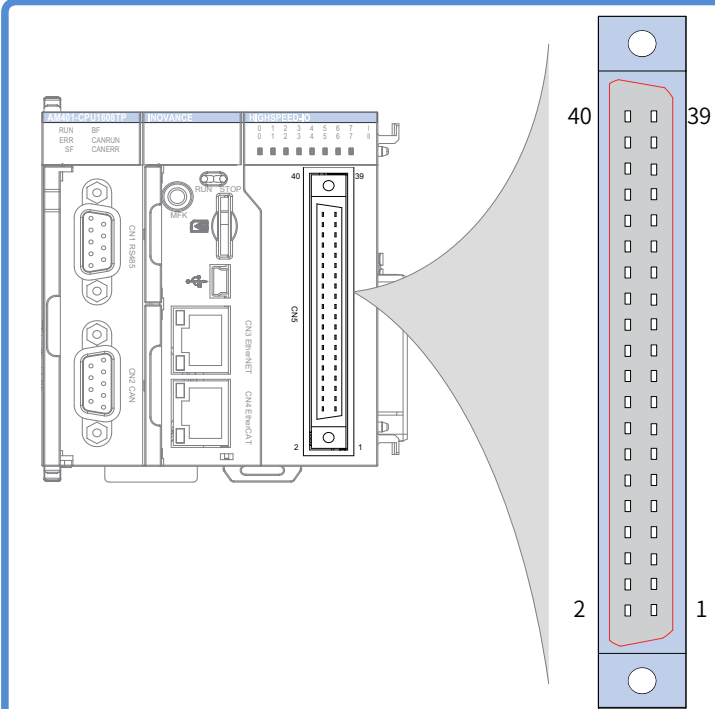

Figure 5 Connection terminal arrangement of the CPU module

External Wiring	Signal Name ColumnB	CN5 Pin No.	Signal Name Column A	Internal Circuit
High-speed 24 V input (Xn2-24V)	High-speed 24 V input (Xn2-24V)	40	39	3.3kΩ
High-speed differential input (Xn2-DIFF)	High-speed differential input (Xn2-DIFF)	38	37	200Ω
High-speed input common terminal (Xn2-COM)	High-speed input common terminal (Xn2-COM)	36	35	
High-speed 24 V input (Xn3-24V)	High-speed 24 V input (Xn3-24V)	34	33	3.3kΩ
Input common terminal (Xn3-DIFF)	High-speed differential input (Xn3-DIFF)	32	31	200Ω
High-speed input common terminal (Xn3-COM)	High-speed input common terminal (Xn3-COM)	30	29	
High-speed 24 V input (Xn4-24V)	High-speed 24 V input (Xn4-24V)	28	27	3.3kΩ
High-speed differential input (Xn4-DIFF)	High-speed differential input (Xn4-DIFF)	26	25	200Ω
High-speed input common terminal (Xn4-COM)	High-speed input common terminal (Xn4-COM)	24	23	
Input common terminal (SS0)	Input common terminal (SS1)	22	21	
Standard input (Xn6)	Standard input (Xn7)	20	19	3.3kΩ
Standard input (Xn8)	Standard input (Xn9)	18	17	3.3kΩ
Standard input (XnA)	Standard input (XnB)	16	15	3.3kΩ
Standard input (XnC)	Standard input (XnD)	14	13	3.3kΩ
Standard input (XnE)	Standard input (XnF)	12	11	3.3kΩ
Output (Yn0)	Output (Yn1)	10	9	Isolating component
Output (Yn2)	Output (Yn3)	8	7	Isolating component
Output (Yn4)	Output (Yn5)	6	5	Isolating component
Output (Yn6)	Output (Yn7)	4	3	Isolating component
Output common terminal (COM0)	Output common terminal (COM1)	2	1	

\*1 When converting the wiring using an external conversion terminal such as SIRON T024-K, pay attention to the actual correspondence of the CN5 terminal of the CPU module.  
\*2 All 16-channel inputs of the CPU module support high-speed input. The first 6-channel inputs support 24 V single-ended or differential input. The last 10-channel inputs support 24 V single-ended input.

Wiring Precautions

- The total extended distance of the high-speed I/O interface extension cable shall be within 3.0 m.
- Do not bundle the extension cable together with power cables (high voltage, large current) which produce strong interference signals. Separate it from other cables and avoid cabling in parallel.
- Select recommended cables and pinboards for connection. It is recommended that shielded cables be used as extension cables to enhance anti-interference ability.
- Ensure that the minimum bending radius of cables is greater than 76 mm when laying extension cables. In the case of 76 mm bending radius, malfunction may occur due to performance degradation and cable breaking.

When converting the wiring using a SIRON T024-K conversion terminal, the following figure shows the relation between terminal numbers and module CN5 pin numbers:

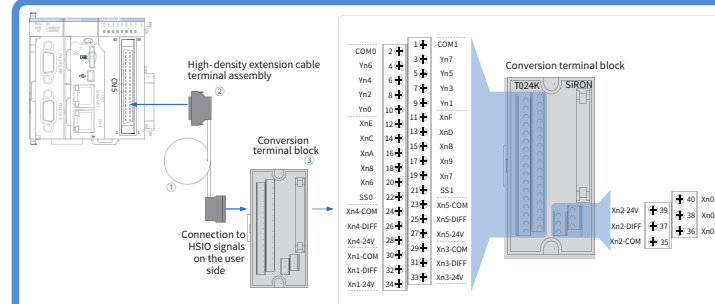

Figure 6 Diagram of terminal block connection

As shown in the preceding figure, ① high-density extension cable ② connecting plug (necessary for any self-made cable) ③ conversion terminal block are available from Inovance. Ordering information is as follows:

NO.	Order Code	Description	Remark
①	15300193	/	40-pin FCN-to-MIL cable (2000 mm) containing one 40-pin FCN connecting plug and one 40-pin MIL connecting plug
	15300119	IO extension cable	40-pin FCN-to-MIL cable (500 mm) containing one 40-pin FCN connecting plug and one 40-pin MIL connecting plug
②	15050180	40-pin FCN connecting plug	You can purchase this plug for any self-made cable.
③	15020452	IO extension card (16DI08DO)	40-pin MIL-to-screw terminal block

5. Communication Connection

Cabling of the CPU Module and Communication Module

- Connection of RJ45 network cable
  - Hold and insert the connector with cable into the RJ45 interface of the communication module until a clicking sound is made.

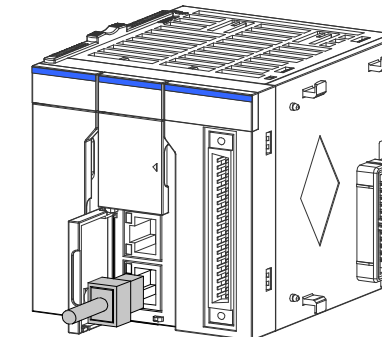

Figure 7 Diagram of network cable connection

- Disassembly procedures: Hold the connector tail mechanism to pull out the connector along a horizontal direction with the module.

Requirements for securing communication cable

To avoid the influence on the communication cable due to other stresses and ensure the stability of communication, please secure the cable near the equipment before EtherCAT and CANopen communication, as shown in the following figure:

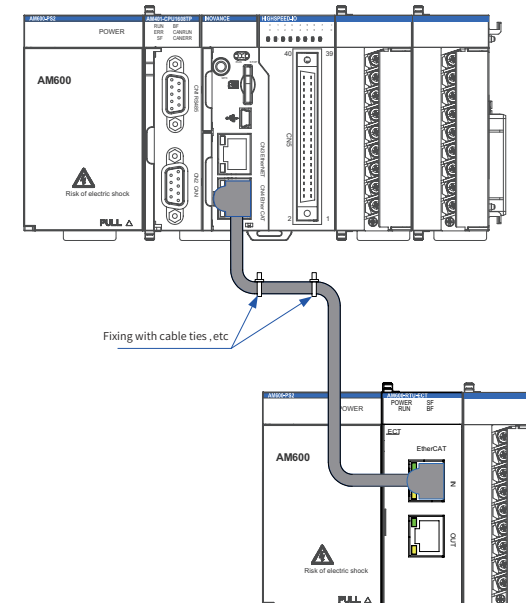

Figure 8 Communication cable must be secured near the equipment



Connection via EtherCAT bus

- 1) EtherCAT Specifications
2) EtherCAT Bus Specifications

Table with 2 columns: Item, Specifications. Lists EtherCAT protocol, service supported, synchronization period, jitter, mode, physical layer, baud rate, duplex mode, topology, transmission medium, distance, slaves, frame length, and process data.

2) Wiring
The CPU module implements EtherCAT bus communication via a CN4 port. Its requirements for the communication network cable are as follows:

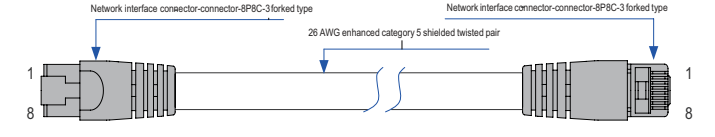

Figure 9 Requirements for EtherCAT network cable preparing

Signal pin assignment

Table with 4 columns: Pin, Signal, Signal Direction, Signal Description. Lists pins 1-8 and their corresponding signals like TD+, TD-, RD+, RD- and their directions.

Length requirements:
FastEthernet technology demonstrates the cable length between devices shall not exceed 100 m when the EtherCAT bus is used.

Technical requirements:
There is no evidence of short circuit, open circuit, displacement and poor contact during the 100% continuity test.

Table with 2 columns: Item, Specifications. Lists cable type, standards compliance, conductor cross-section, and type.

Connection via CANopen/CANlink Bus

1) Diagram of Networking
CAN bus topology is shown below. Using shielded twisted cables to connect CAN bus is recommended.

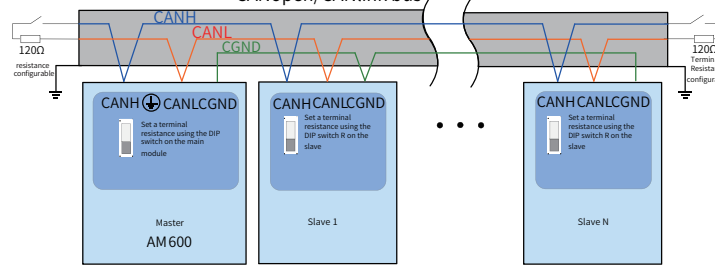

Figure 10 Diagram of CANopen/CANlink communication connection

2) Communication Interface Description
CN2 of the CPU module is a CANopen communication interface. The module uses a DB9 connector for data transfer.

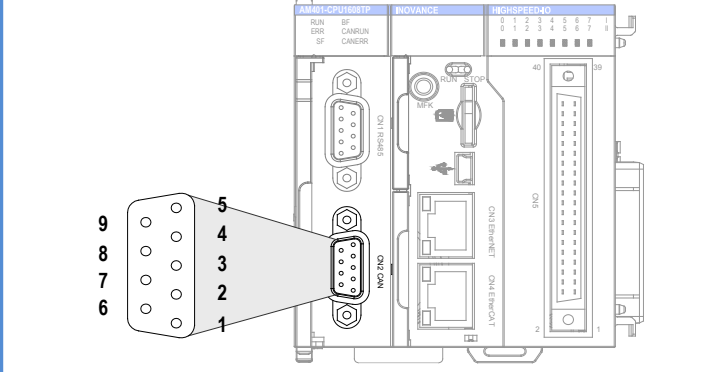

Figure 11 CANopen terminal definition on CPU module

3) Wiring
CANopen uses a DB9 connector for data transfer. Below is the definition of DB9 pins:

Table with 3 columns: Diagram, Pin, Definition of signal. Maps DB9 pins 1-9 to CANL, CANH, and GND.

Use shielded twisted cable to connect CAN bus, and attach a 120Ω terminal matching resistance to each end of the bus to prevent signal reflection.

Serial Communication Connection via RS485

1) Communication Interface Description
CN1 in the figure shows the RS485 interface. Two RS485 interfaces are supported. Two RS485 channels share the same DB9 interface.

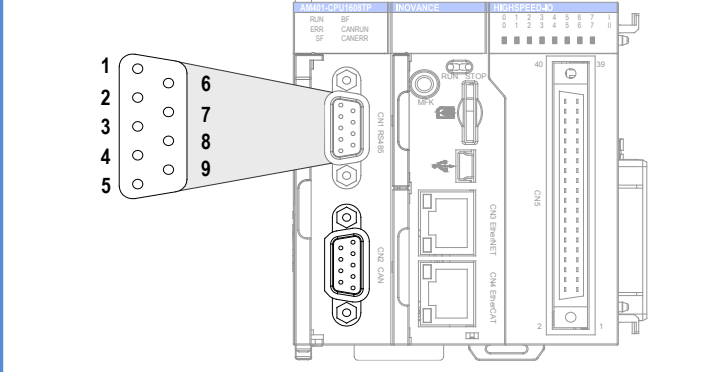

Figure 12 RS485 communication terminal definition on CPU module

Definition of DB9 assignment:

Table with 4 columns: Channel, Pin, Definition, Function. Lists COM0 and COM1 RS485 differential pairs and power ground connections.

Connection via Ethernet Monitoring

1) Diagram of Networking
The Ethernet interface of the CPU module can perform point-to-point connection to a computer, HMI, etc. using an Ethernet cable.

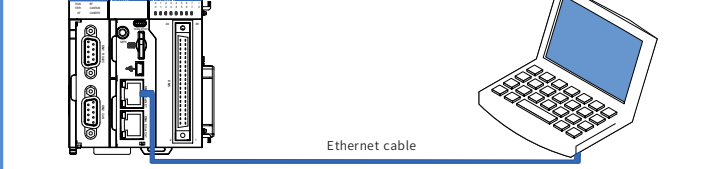

Figure 13 Connection of the CPU module to a PC

It can also be connected to a hub or switch using an Ethernet cable and then to other network equipment via the hub or switch to implement multi-point connection.

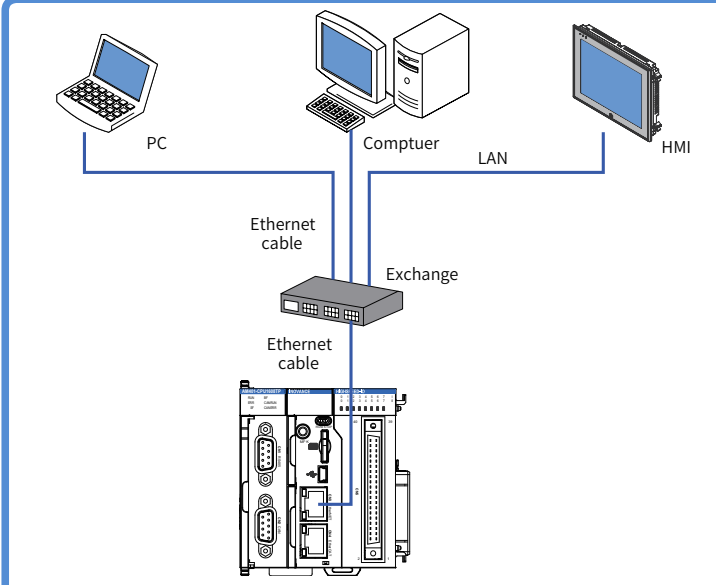

Figure 14 Connection of the CPU module to other equipment via a switch

2) Wiring
To improve equipment communication reliability, the Ethernet cable must be a category 5 shielded twisted pair with iron case molding line.

6. Programming tool downloading

Programming Tool Downloading

The user programming software for Inovance AM400 series medium-sized PLC is a free software. You can obtain a software DVD from an Inovance distributor, or download it from the data downloading webpage at Inovance official website.

Inovance improves its products and data continuously. It is recommended to update software and refer to any updated and issued reference data to facilitate your application design, if necessary.

Programming Environment and Software Installation

Environment Requirements
Hardware requirements: One desktop PC or portable computer with Windows 7 or later version of the operating system; 2 GB computer RAM contents, over 5 GB remaining space in the hard disk or SSD.

An LAN network cable can also be used for connection between the PC and the AM400 controller. It is recommended to connect AM400 to the LAN via a router. This allows a greater distance between the PC and the AM400, e.g. performing programming on the AM400 located in the workshop by staying at the office.

A USB cable can also be used for connection between the PC and the AM400 controller. In this case, one USB cable is needed and a MiniUSB plug must be provided at one end of its cable.

7. Operation and Maintenance

Run and Stop Operations

After a program is written to the CPU module, perform the startup and shutdown operations in the following steps.
After a program is written to the CPU module in STOP state, when running the system:

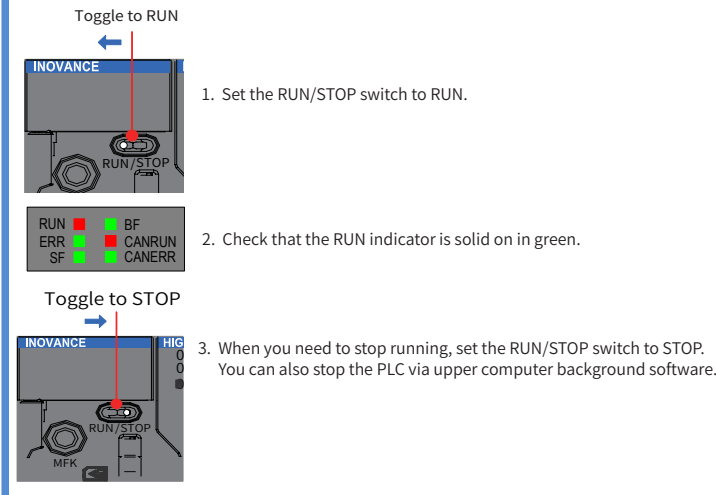

8. Description of Indicators and MFK Key

CPU Module Indicators

Table with 2 columns: Indicator Name, Description. Lists RUN indicator, ERR indicator, SF indicator, and BF indicator with their respective functions.

MFK Key Description

The main function of the MFK key is an IP address reset command key of the PLC main module and is valid when the PLC is in STOP state.
The factory default IP address of the CPU module is 192.168.1.88. If this address is modified, before communication with another PC for networking, communication may fail due to forgetting the last modified IP address.

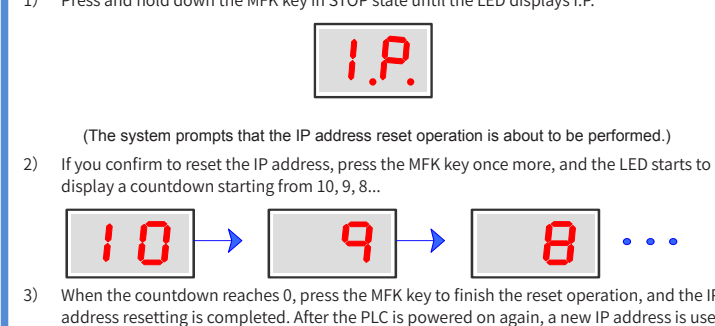

8. Description of Indicators and MFK Key

CPU Module LED Display

When the system fails, the fault code information will be displayed through the LED on the CPU. The display mode is "E.r. and fault code" that appear alternatively. Assume that the fault code is 40, the LED display is shown in the following figure:

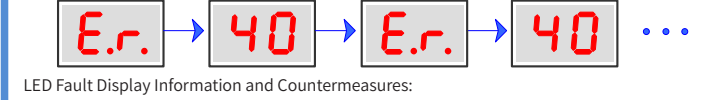

Table with 3 columns: Local Bus of CPU Module and Diagnosis LED Display of I/O Module, Description, Countermeasures. Lists fault codes 00, 40, 41, 42 with their descriptions and countermeasures.

Table with 3 columns: High-speed I/O LED Display, Description, Countermeasures. Lists fault codes 60, 61, 62, 63 with their descriptions and countermeasures.

Table with 3 columns: ModBus LED Display, Description, Countermeasures. Lists fault codes 70, 80, 90 with their descriptions and countermeasures.

9. Module Connection

Connecting the Power, CPU and Expansion Modules

Table with 3 columns: CANopen LED Display, Description, Countermeasures. Lists fault codes C0, C1, C2, CF with their descriptions and countermeasures.

Table with 3 columns: CANlink LED display, Description, Countermeasures. Lists fault codes d0, d1, d2, d3, d4 with their descriptions and countermeasures.

9. Module Connection

Connecting the Power, CPU and Expansion Modules

Connection between modules is mainly fixed using a module connection interface, fixed lock catch, etc. Take as a sample the connection of the CPU module to the power module.

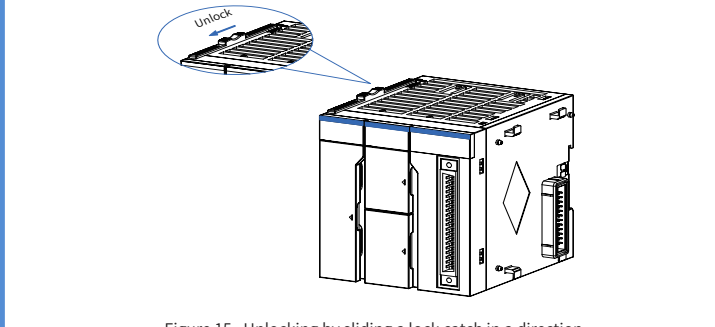

Figure 15 Unlocking by sliding a lock catch in a direction

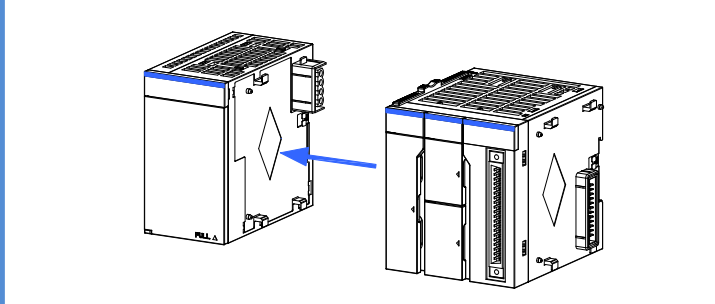

Figure 16 Connecting the connector on the power module

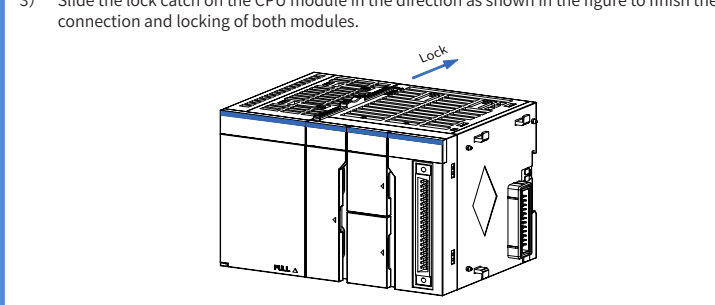

Figure 17 Locking by sliding a lock catch in a direction

Connecting the Power, CPU and Expansion Modules

1) Pull out downwards all DIN guide rail mounting hooks on the back of the module (as shown in the following local diagram) until a clicking sound is made.

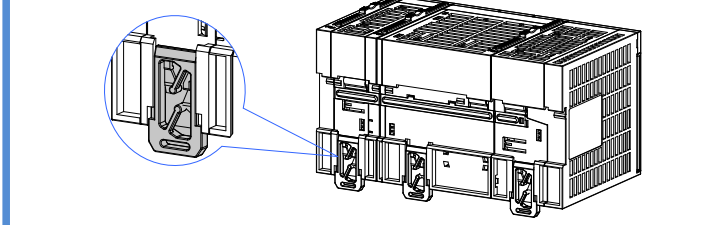

Figure 18 Pulling down hooks on the modules

2) Hang the fixed jaw on the upper side of the module to the upper side of the DIN guide rail in direction A as shown in the figure. Press the module group hard in direction B as shown in the figure until it is fully embedded into the guide rail.

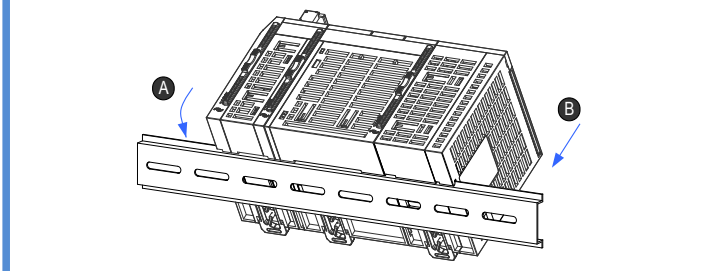

Figure 19 Clamping the module into the DIN rail

3) After locking the DIN guide rail mounting hooks on the module, embed the module to the DIN guide rail. Press upwards until a clicking sound is made. In addition, tools such as screwdrivers shall be used in the case that no finger can reach the DIN guide rail mounting hooks.

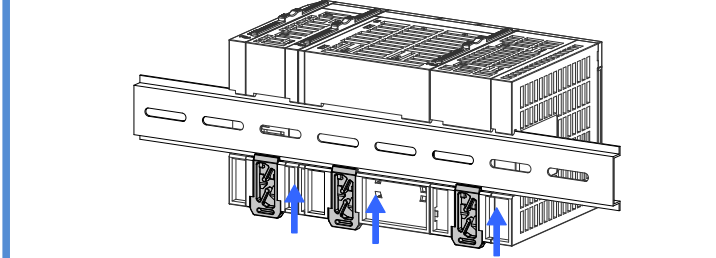

Figure 20 Clamping hooks on the modules in the arrow direction

INOVANCE Warranty Agreement

- 1) Inovance provides 18-month free warranty to the equipment itself from the date of manufacturing for the failure or damage under normal use conditions.
2) Within the warranty period, maintenance will be charged for the damages caused by the following reasons:
a. Improper use or repair/modification without prior permission
b. Fire, flood, abnormal voltage, other disasters and secondary disasters
c. Hardware damage caused by dropping or transportation after procurement
d. Improper operations
e. Damage out of the equipment (for example, external device factors)
3) The maintenance fee is charged according to the latest Maintenance Price List of Inovance.
4) If there is any problem during the service, contact Inovance's agent or Inovance directly.
5) Inovance reserves the rights for explanation of this agreement.

Suzhou Inovance Technology Co., Ltd.
Address: No.16, Youxiang Road, Yuexi Town, Wuzhong District, Suzhou 215104, P.R. China
Website: http://www.inovance.com