



User Guide

CP700 Series AC Drive

For Air Compressors



Preface

Thank you for purchasing the CP700 series AC drive for air compressors developed and manufactured by Inovance.

The CP700 series AC drive for air compressors has the following features:

- **Easy mounting:** The sheet metal structure is adopted with wall-mounting supported.
- **Simplified wiring and commissioning:** The control circuit terminal uses plug-in connector terminals with error proofing design.
- **High integration:** The AC drive is equipped with built-in 220 VAC power supply for 24 V output, a mains frequency contactor, and built-in detection and protection circuits such as PT100 and PTC. The AC drive uses dedicated software to communicate with HMI and Internet of Things (IoT) equipment without commissioning, which supports one-button startup.

This user guide describes the correct use of the CP700 series AC drive for air compressors, including selection, mounting, wiring, and commissioning. Read and understand the user guide before use and forward the user guide to end users.

About the User Guide

Read and understand the user guide before use. Contact our technical support personnel if you have any question during the use.

Standards Compliance

The following table lists the certifications and standards that the product may comply with. For details about the acquired certifications, see the certification marks on the product nameplate.

Name	Directive Name		Standard
CE certification	EMC Directive	2014/30/EU	EN 61800-3
	LVD Directive	2014/35/EU	EN 61800-5-1
	RoHS Directive	2011/65/EU	EN 50581
TUV certification	-		EN 61800-5-1
UL certification			UL508C/UL61800-5-1 C22.2 No.14-13

Revision History

Date	Version	Revision Description
November 2018	A00	First release.
April 2019	A01	<ul style="list-style-type: none"> ◆ Updated Inovance's logo. ◆ Updated the certification description in Preface.
July 2019	A02	<ul style="list-style-type: none"> ◆ Added data of the 90 kW models in the following sections: <ul style="list-style-type: none"> 1.1 Nameplate and Model Number 1.3 Technical Data 1.4 Overall Dimensions 2.4.1 Main Power Cables 5.3.2 Number of Cooling Fans ◆ Updated data of F9-17 to F9-45 in "A.1 Standard Parameter Table". ◆ Added group A4 parameters and A8-80 to A8-86 in "A.1 Standard Parameter Table". ◆ Added U0-76 and U0-87 to U0-95 in "A.2 Monitoring Parameters". ◆ Modified data of U0-77.

Acquisition

This user guide is shipped with the product. You can contact your sales representative for any additional order.

To obtain the electronic version of the user guide, log in to Inovance's website (<http://www.inovance.com>), click "Download", search the user guide name, and then download the PDF.

Contents

Preface	1
Revision History	2
Safety Instructions	5
Safety Precautions.....	5
Safety Levels and Definitions	5
Safety Instructions.....	5
Safety Signs.....	10
1 Product Information.....	11
1.1 Nameplate and Model Number	11
1.2 Components	12
1.3 Technical Data.....	13
1.4 Overall Dimensions.....	16
1.5 Recommended System Solution.....	18
1.5.1 CP700 System Structure	18
1.5.2 Peripheral Electrical Devices	19
2 Installation and Wiring.....	21
2.1 Installation	21
2.1.1 Installation Environment	21
2.1.2 Installation Clearance Requirements	22
2.1.3 Cover Removal and Mounting.....	22
2.2 Wiring.....	24
2.2.1 Main Circuit Terminal Arrangement.....	24
2.2.2 Control Terminal Arrangement.....	26
2.2.3 Control Terminal Wiring.....	29
2.3 Power Grid System Requirement	30
2.4 Wiring Recommendations.....	30
2.4.1 Main Power Cables	30
2.4.2 Control Cables.....	32
3 Display Description and Commissioning.....	33
3.1 Indicator Description.....	33
3.2 Commissioning Process.....	34
3.3 System Commissioning Case Study.....	35
4 Troubleshooting.....	39

4.1 Fault Codes and Solutions	39
4.2 Symptoms and Solutions.....	50
5 Maintenance	52
5.1 Daily Maintenance	52
5.2 Periodic Inspection.....	53
5.3 Replacement of Wear Parts.....	53
5.3.1 Lifetime of Wear Parts.....	53
5.3.2 Number of Cooling Fans.....	54
5.3 Replacing Cooling Fans.....	54
5.4 Storage	57
Appendix A Parameter Table	58
A.1 Standard Parameter Table.....	58
A.2 Monitoring Parameters	109
Warranty Agreement.....	112

Safety Instructions

Safety Precautions

- 1) Before installing, using, and maintaining this equipment, read the safety information and precautions thoroughly, and comply with them during operations.
- 2) To ensure the safety of humans and equipment, follow the signs on the equipment and all the safety instructions in this user guide.
- 3) "CAUTION", "WARNING", and "DANGER" items in the user guide do not indicate all safety precautions that need to be followed; instead, they just supplement the safety precautions.
- 4) Use this equipment according to the designated environment requirements. Damage caused by improper usage is not covered by warranty.
- 5) Inovance shall take no responsibility for any personal injuries or property damage caused by improper usage.

Safety Levels and Definitions

**DANGER**

indicates that failure to comply with the notice will result in severe personal injuries or even death.

**WARNING**

indicates that failure to comply with the notice may result in severe personal injuries or even death.

**CAUTION**

indicates that failure to comply with the notice may result in minor personal injuries or damage to the equipment.

Safety Instructions

Unpacking

**CAUTION**

- ◆ Check whether the packing is intact and whether there is damage, water seepage, damp, and deformation.
- ◆ Unpack the package by following the package sequence. Do not hit the package with force.
- ◆ Check whether there are damage, rust, or injuries on the surface of the equipment or equipment accessories.
- ◆ Check whether the number of packing materials is consistent with the packing list.

 **WARNING**

- ◆ Do not install the equipment if you find damage, rust, or indications of use on the equipment or accessories.
- ◆ Do not install the equipment if you find water seepage, component missing or damage upon unpacking.
- ◆ Do not install the equipment if you find the packing list does not conform to the equipment you received.

Storage and Transportation

 **CAUTION**

- ◆ Store and transport this equipment based on the storage and transportation requirements for humidity and temperature.
- ◆ Avoid transporting the equipment in environments such as water splashing, rain, direct sunlight, strong electric field, strong magnetic field, and strong vibration.
- ◆ Avoid storing this equipment for more than three months. Long-term storage requires stricter protection and necessary inspections.
- ◆ Pack the equipment strictly before transportation. Use a sealed box for long-distance transportation.
- ◆ Never transport this equipment with other equipment or materials that may harm or have negative impacts on this equipment.

 **WARNING**

- ◆ Use professional loading and unloading equipment to carry large-scale or heavy equipment.
- ◆ When carrying this equipment with bare hands, hold the equipment casing firmly with care to prevent parts falling. Failure to comply may result in personal injuries.
- ◆ Handle the equipment with care during transportation and mind your step to prevent personal injuries or equipment damage.
- ◆ Never stand or stay below the equipment when the equipment is lifted by hoisting equipment.

Installation

 **WARNING**

- ◆ Thoroughly read the safety instructions and user guide before installation.
- ◆ Do not modify this equipment.
- ◆ Do not rotate the equipment components or loosen fixed bolts (especially those marked in red) on equipment components.
- ◆ Do not install this equipment in places with strong electric or magnetic fields.
- ◆ When this equipment is installed in a cabinet or final equipment, protection measures such as a fireproof enclosure, electrical enclosure, or mechanical enclosure must be provided. The IP rating must meet IEC standards and local laws and regulations.

**DANGER**





- ◆ Equipment installation, wiring, maintenance, inspection, or parts replacement must be performed by only professionals.
- ◆ Installation, wiring, maintenance, inspection, or parts replacement must be performed by only experienced personnel who have been trained with necessary electrical information.
- ◆ Installation personnel must be familiar with equipment installation requirements and relevant technical materials.
- ◆ Before installing equipment with strong electromagnetic interference, such as a transformer, install an electromagnetic shielding device for this equipment to prevent malfunctions.

Wiring**DANGER**

- ◆ Equipment installation, wiring, maintenance, inspection, or parts replacement must be performed by only professionals.
- ◆ Never perform wiring at power-on. Failure to comply will result in an electric shock.
- ◆ Before wiring, cut off all equipment power supplies. Wait at least 10 minutes before further operations because residual voltage exists after power-off.
- ◆ Make sure that the equipment is well grounded. Failure to comply will result in an electric shock.
- ◆ During wiring, follow the proper electrostatic discharge (ESD) procedures, and wear an antistatic wrist strap. Failure to comply will result in damage to internal equipment circuits.

**WARNING**

- ◆ Never connect the power cable to output terminals of the equipment. Failure to comply may cause equipment damage or even a fire.
- ◆ When connecting a drive with the motor, make sure that the phase sequences of the drive and motor terminals are consistent to prevent reverse motor rotation.
- ◆ Wiring cables must meet diameter and shielding requirements. The shielding layer of the shielded cable must be reliably grounded at one end.
- ◆ After wiring, make sure that no screws are fallen and cables are exposed in the equipment.

Power-on
<div style="border: 1px solid black; padding: 2px; display: inline-block;">  DANGER </div> <ul style="list-style-type: none"> ◆ Before power-on, make sure that the equipment is installed properly with reliable wiring and the motor can be restarted. ◆ Before power-on, make sure that the power supply meets equipment requirements to prevent equipment damage or even a fire. ◆ At power-on, unexpected operations may be triggered on the equipment. Therefore, stay away from the equipment. ◆ After power-on, do not open the cabinet door and protective cover of the equipment. Failure to comply will result in an electric shock. ◆ Do not touch any wiring terminals at power-on. Failure to comply will result in an electric shock. ◆ Do not remove any part of the equipment at power-on. Failure to comply will result in an electric shock.
Operation
<div style="border: 1px solid black; padding: 2px; display: inline-block;">  DANGER </div> <ul style="list-style-type: none"> ◆ Do not touch any wiring terminals during operation. Failure to comply will result in an electric shock. ◆ Do not remove any part of the equipment during operation. Failure to comply will result in an electric shock. ◆ Do not touch the equipment shell, fan, or resistor for temperature detection. Failure to comply will result in heat injuries. ◆ Signal detection must be performed by only professionals during operation. Failure to comply will result in personal injuries or equipment damage.
<div style="border: 1px solid black; padding: 2px; display: inline-block;">  WARNING </div> <ul style="list-style-type: none"> ◆ Prevent metal or other objects from falling into the device during operation. Failure to comply may result in equipment damage. ◆ Do not start or stop the equipment using the contactor. Failure to comply may result in equipment damage.
Maintenance
<div style="border: 1px solid black; padding: 2px; display: inline-block;">  DANGER </div> <ul style="list-style-type: none"> ◆ Equipment installation, wiring, maintenance, inspection, or parts replacement must be performed by only professionals. ◆ Do not maintain the equipment at power-on. Failure to comply will result in an electric shock. ◆ Before maintenance, cut off all equipment power supplies and wait at least 10 minutes.



- ◆ Perform daily and periodic inspection and maintenance for the equipment according to maintenance requirements and keep a maintenance record.

Repair



- ◆ Equipment installation, wiring, maintenance, inspection, or parts replacement must be performed by only professionals.
- ◆ Do not repair the equipment at power-on. Failure to comply will result in an electric shock.
- ◆ Before inspection and repair, cut off all equipment power supplies and wait at least 10 minutes.



- ◆ Require repair services according to the product warranty agreement.
- ◆ When the equipment is faulty or damaged, require professionals to perform troubleshooting and repair by following repair instructions and keep a repair record.
- ◆ Replace quick-wear parts of the equipment according to the replacement guide.
- ◆ Do not operate damaged equipment. Failure to comply may result in worse damage.
- ◆ After the equipment is replaced, perform wiring inspection and parameter settings again.

Disposal



- ◆ Retire equipment by following local regulations or standards. Failure to comply may result in property damage, personal injuries, or even death.
- ◆ Dispose of or recycle retired equipment by following industry waste disposal standards to avoid environmental pollution.

Safety Signs

■ Description of safety signs in the user guide



Read the user guide before installation and operation.



Reliably ground the system and equipment.



Danger!



High temperature!



Prevent personal injuries caused by machines.



High voltage!



Wait xx minutes before further operations.

■ Description of safety signs on the equipment

For safe equipment operation and maintenance, comply with safety signs on the equipment, and do not damage or remove the safety labels. The following table describes the safety signs.

Safety Sign	Description
	<ul style="list-style-type: none"> ◆ Read the user guide before installation and operation. Failure to comply will result in an electric shock. ◆ Do not remove the cover at power-on or within 10 minutes after power-off. ◆ Before maintenance, inspection, and wiring, cut off input and output power, and wait at least 10 minutes until the power indicator is off.

1 Product Information

1.1 Nameplate and Model Number

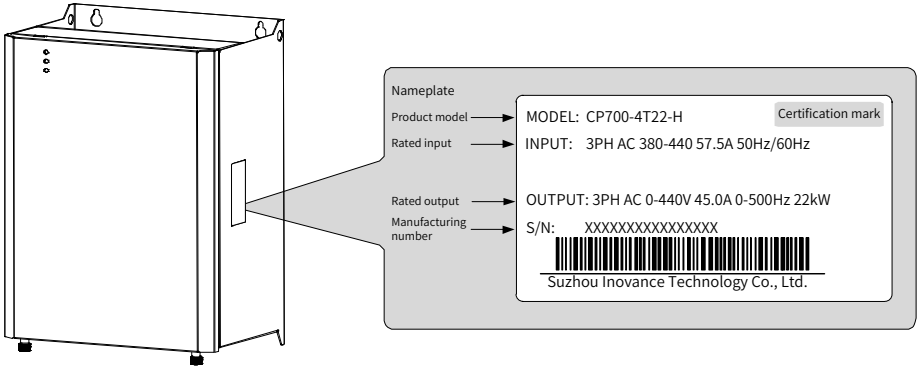

CP700 - 4T 22 - H

ID	Product Series
CP700	AC drive for air compressors

ID	Voltage Class
2T	Three phase 200-240 V
4T	Three phase 380-440 V

ID	Mounting Mode
H	Backplate mounting

ID	Motor (kW)
5.5	5.5
...	
90	90

Figure 1-1 Nameplate and model number

1.2 Components

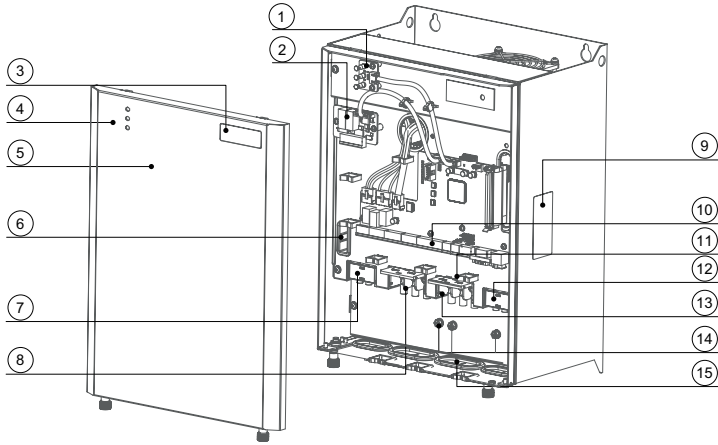

Figure 1-2 Component diagram (CP700-4T18.5-H to CP700-4T22-H)

No.	Component Name	No.	Component Name
1	LED indicator panel	9	Nameplate
2	STO card (optional)	10	Control circuit port
3	Logo	11	Wire bracket
4	Indicator	12	Variable frequency cooling blower terminal
5	Front cover	13	Air end output terminal
6	EMC screw/voltage dependent resistor (VDR) grounding terminal	14	Grounding terminal
7	Mains frequency cooling blower terminal	15	Protective ring
8	Input terminal		



Figure 1-2 shows components of CP700-4T18.5-H to CP700-4T22-H as an example. Other model description varies with actual components.

1.3 Technical Data

Table 1-1 CP700 series AC drive models and technical data

Model	Main Cooling Blower			Variable Frequency Cooling Blower		Mains Frequency Cooling Blower	
	Power (kW)	Input Current (A)	Output Current (A)	Power (kW)	Rated Current (A)	Power (kW)	Rated Current (A)
Three phase 200 VAC to 240 VAC, 50/60 Hz							
CP700-2T7.5-H	7.5	35.0	32.0	/	/	0.25	1.5
CP700-2T11-H	11	49.5	45.0	0.45	2.1	0.45	2.1
CP700-2T15-H	15	60.0	55.0	0.45	2.1	0.45	2.1
CP700-2T18.5-H	18.5	65.0	60.0	0.75	3.8	0.45	2.1
CP700-2T22-H	22	80	75	0.75	3.8	0.45	2.1
CP700-2T30-H	30	120.9	112	2.2	9.0	0.45	2.1
CP700-2T37-H	37	134.0	125.0	2.2	9.0	0.45	2.1
CP700-2T45-H	45	159.2	150.0	2.2	9.0	0.45	2.1
Three phase 380 VAC to 440 VAC, 50/60 Hz							
CP700-4T5.5-H	5.5	15.9	13	/	/	0.4	1.5
CP700-4T7.5-H	7.5	20.5	17	/	/	0.4	1.5
CP700-4T11-H	11	26	25	/	/	0.4	1.5
CP700-4T15-H	15	35	32	/	/	0.4	1.5
CP700-4T18.5-H	18.5	47.2	37.0	0.75	2.1	0.75	2.1
CP700-4T22-H	22	57.5	45.0	0.75	2.1	0.75	2.1
CP700-4T30-H	30	65.0	60.0	1.5	3.8	0.75	2.1
CP700-4T37-H	37	80.0	75.0	1.5	3.8	0.75	2.1
CP700-4T45-H	45	101.4	91.0	3.7	9.0	0.75	2.1
CP700-4T55-H	55	122.3	112.0	3.7	9.0	0.75	2.1
CP700-4T75-H	75	164.6	150.0	3.7	9.0	0.75	2.1
CP700-4T90-H	90	186.0	176.0	3.7	9.0	0.75	2.1

Table 1-2 CP700 series technical data

	Item	Specification
Basic parameters	Output frequency	Vector control: 0–500 Hz
	Carrier frequency	2–8 kHz: The carrier frequency is adjusted automatically according to heatsink temperature.
	Input frequency resolution	Digital setting: 0.01 Hz
	AC drive capacity	Three phase 220 V: 7.5–45 kW Three phase 380 V: 5.5–75 kW
	Input voltage	Three phase 220 V: 220–240 VAC Three phase 380 V: 380–440 VAC
	Voltage fluctuation range	–15% to +10%
	Control mode	Speed sensorless vector control (SVC)
	Speed range	1:50 (SVC, power driven)
	Speed control accuracy	±0.1% (SVC)
	Speed fluctuation	1.5% (SVC); 3.0% (flux weakening region)
	Torque response	< 15 ms (SVC)
	Torque fluctuation	< 15% (SVC, power generation); < 12% (motoring)
	Torque control mode	SVC
	Overload capacity	The air end overload current multiple and overload time are automatically calculated based on module temperature.
Customized features	Acceleration/Deceleration curve	Straight line, S curve mode 1, and S curve mode 2
	Built-in PID	Built-in specialized pressure and temperature PID parameters for pressure and temperature control
	Communication/Bus	Standard RS485
	Running command channel	Two channels: terminal and communication command setting
	Frequency source	Digital setting

Item		Specification
HMI	Analog input	Two for the pressure sensor: 0–20 mA input, 12-bit resolution, and correction accuracy of 0.5%
		Two for the temperature sensor: resistance input, 12-bit resolution, and correction accuracy of 0.5%
	Digital input	Four common inputs: NPN input method
		Two PTC protective circuits (compatible with common inputs)
	Digital output	Two normally open (NO) relay outputs
LED indicator	Three LED indicators (standard configuration)	
Protection function	Short-circuit to ground upon power-on, motor overheat (PTC), AC drive overcurrent, AC drive overload, motor overload, AC drive overvoltage, AC drive undervoltage, AC drive overheat, output phase loss, input phase loss, communication fault, phase detection fault, current detection fault, motor auto-tuning fault, EEPROM read-write fault, and buffer resistance fault	
Air compressor control logic	Constant pressure value, unloading pressure, sleep wake-up pressure, shutdown preparation time, shutdown block time, constant temperature value, fan startup temperature, fan stop temperature, pre-operation frequency, pre-operation time, PID pressure adjustment, PID temperature adjustment, and solenoid valve control	
Environment	Operating location	Free from direct sunlight, dust, corrosive gas, combustible gas, oil mist, vapor, drip, or salt indoor
	Altitude	Max. 3000 m; de-rated by 1% per 100 m when the altitude is above 1000 m
	Operating temperature	–10°C to +50°C
	Humidity	Less than 95% RH without condensing
	Vibration	Less than 9.8 m/s ² (1G)
	Storage temperature	–20°C to +60°C

1.4 Overall Dimensions

The CP700 series AC drive for air compressors can be mounted on the wall. The specific mounting dimensions are as follows.

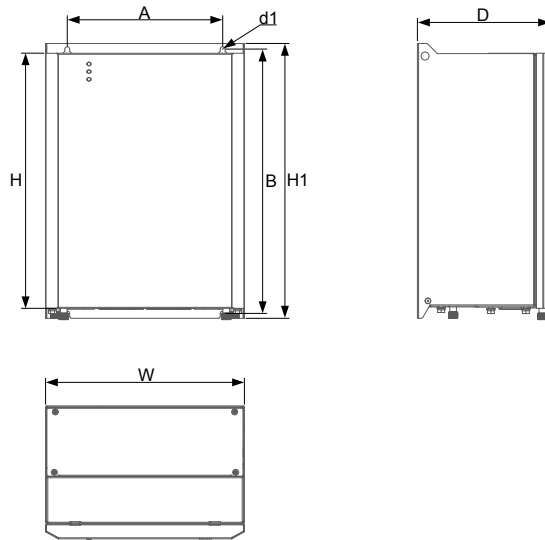

Figure 1-3 Wall-mounting dimensions

Table 1-3 Physical dimensions and mounting hole diameters of wall-mounted models

AC Drive Model	Physical Dimensions (mm)				Mounting Dimensions (mm)			Weight (kg)
	H1	H	W	D	A	B	d1	
Three phase 200 VAC to 240 VAC, 50/60 Hz								
CP700-2T7.5-H	384	357	208	176	180	371	φ6	9.5
CP700-2T11-H	393	365	284	190	222	378	φ7	14.5
CP700-2T15-H	393	365	284	190	222	378	φ7	14.5
CP700-2T18.5-H	423	395	315	215	253	408	φ7	24.3
CP700-2T22-H	423	395	315	215	253	408	φ7	24.3
CP700-2T30-H	501	485	366	258	294	478	φ10	33.8
CP700-2T37-H	501	485	366	258	294	478	φ10	33.8
CP700-2T45-H	525	509	400	260	328	502	φ10	42.0
Three phase 380 VAC to 440 VAC, 50/60 Hz								
CP700-4T5.5-H	344	317	168	176	140	331	φ6	7.0
CP700-4T7.5-H	344	317	168	176	140	331	φ6	7.0
CP700-4T11-H	384	357	208	176	180	371	φ6	9.5
CP700-4T15-H	384	357	208	176	180	371	φ6	9.5
CP700-4T18.5-H	393	365	284	190	222	378	φ7	14.5
CP700-4T22-H	393	365	284	190	222	378	φ7	14.5
CP700-4T30-H	423	395	315	215	253	408	φ7	24.3
CP700-4T37-H	423	395	315	215	253	408	φ7	24.3
CP700-4T45-H	501	485	366	258	294	478	φ10	33.8
CP700-4T55-H	501	485	366	258	294	478	φ10	33.8
CP700-4T75-H	525	509	400	260	328	502	φ10	42.0
CP700-4T90-H	525	509	400	260	328	502	φ10	42.0

1.5 Recommended System Solution

1.5.1 CP700 System Structure

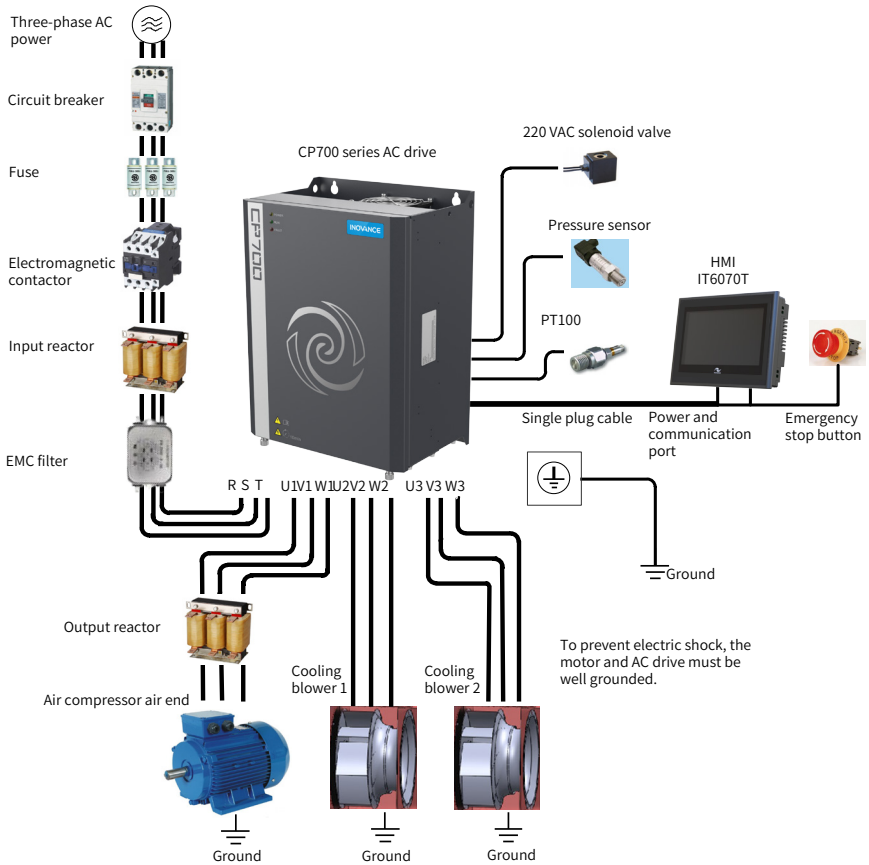

Figure 1-4 CP700 system structure

1.5.2 Peripheral Electrical Devices

Table 1-4 Description of peripheral electrical devices of the CP700 AC system

Part Name	Mounting Location	Function Description
Circuit breaker	Between power supply and AC drive input side	Short circuit breaker: cuts off power supply when overcurrent occurs on downstream devices, so as to prevent accidents.
		Leakage breaker: provides protection against potential high-frequency leakage current during AC drive running to prevent electric shock and even a fire. Choose proper leakage breaker according to the field situation.
Fuse	Between power supply and AC drive input side	Provides protection in case of short circuit and protect downstream semiconductor components.
(Electromagnetism) Contactor	Between the breaker and AC drive input side	Used for applying or cutting off power supply of the AC drive. Do not start and stop the AC drive frequently by switching the contactor on and off (at least 1-hour interval) nor use it to directly start the AC drive.
Input reactor	AC drive input side	Used for improving the power factor of power input side. Eliminates higher harmonics of the input side effectively and prevents other devices from being damaged due to distortion of voltage waveform. Eliminates input current unbalance caused by inter-phase unbalance.
EMC filter	AC drive input side	Reduces external conduction and radiation interference of the AC drive. Decreases conduction interference flowing from power supply to the AC drive and improves the anti-interference capacity of the AC drive.
Output reactor	Between the AC drive output side and motor (close to the AC drive)	The output side of an AC drive usually has much higher harmonics. When a motor is far away from the AC drive, much distributed capacitance exists in the circuit. Certain harmonics may cause resonance in the circuit, which will: 1) Degrade motor insulation performance and damage motor in the long run. 2) Generate large leakage current and cause frequent AC drive protection trips. If the distance between an AC drive and a motor is greater than 100 m, it is recommended that an AC output reactor be installed.
dv/dt reactor	AC drive output side (close to the AC drive)	The optional dv/dt drive ensures motor insulation and reduces bearing current.
Output magnetic loop	AC drive output side (close to the AC drive)	Reduces bearing current.

1 Product Information

Part Name	Mounting Location	Function Description
Air compressor air end	AC drive output side	Supplies energy to the air end.
Air compressor cooling blower	AC drive output side	Supplies cooling air to the air compressor system.
220 VAC solenoid valve	AC drive control terminal	Used for control system air intake.
Pressure sensor	AC drive control terminal	Detects output system pressure.
PT100	AC drive control terminal	Detects head cycle oil temperature of the air compressor.
HMI	System connection	Used as the air compressor display module.
Emergency stop switch	System connection	Used for stopping the air compressor system in emergent situations.
IoT	System connection	Used as the network connection port of the air compressor system.

2 Installation and Wiring

2.1 Installation

2.1.1 Installation Environment

- 1) Ambient temperature: Ambient temperature has a great effect on the AC drive's life. The operating ambient temperature of the AC drive must not exceed the allowable temperature range (-10°C to +50°C).
- 2) The installation surface of the AC drive must be flame retardant. A large amount of heat may be generated during the operation of the AC drive. Therefore, leave enough space for heat dissipation, and install the AC drive vertically to the mounting support using screws.
- 3) Install the AC drive in a place with no vibration. Vibration must not be greater than 1G. Keep away from devices such as punch presses.
- 4) Install the AC drive in an environment free from direct sunlight, moisture, and water drops.
- 5) Install the AC drive in an environment free from corrosive, inflammable, or explosive gases.
- 6) Install the AC drive in an environment free from grease dirt and dust.

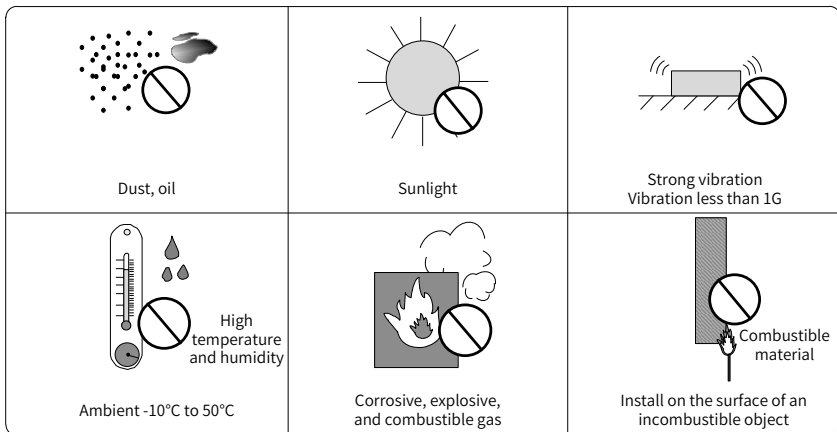

Figure 2-1 Installation environment

- 7) The AC drive must be installed in a fireproof cabinet with doors that provide effective electrical and mechanical protection. The installation must conform to local and regional laws and regulations, and to relevant IEC requirements.

2.1.2 Installation Clearance Requirements

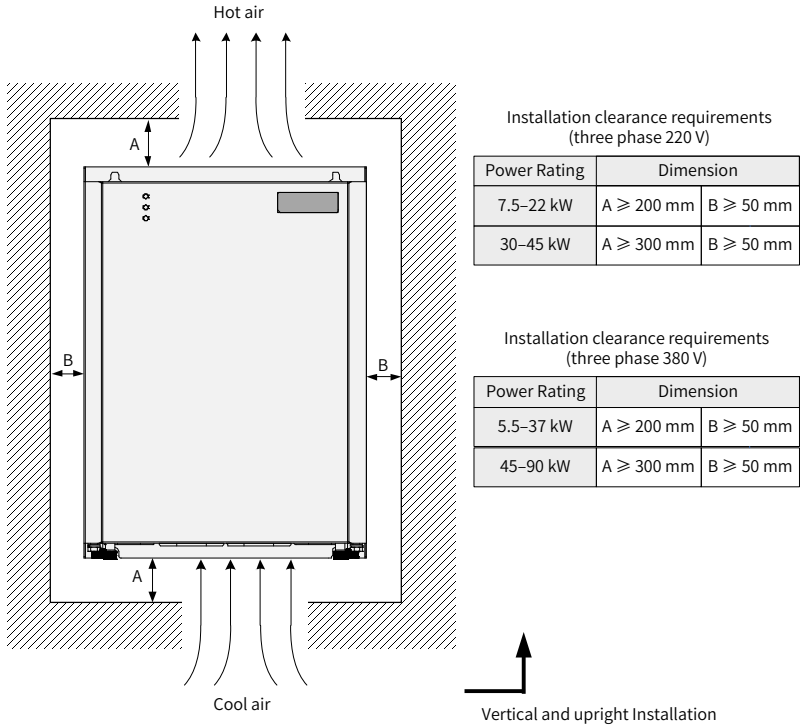
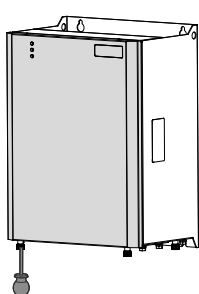

Figure 2-2 Installation clearance requirements

2.1.3 Cover Removal and Mounting

Follow the guidelines below for cover removal and mounting.

Cover removal procedures	
	<p>Step 1: Screw out two captive screws of the cover at the bottom using an inner hexagon screwdriver or inner hexagon wrench.</p>

Cover removal procedures

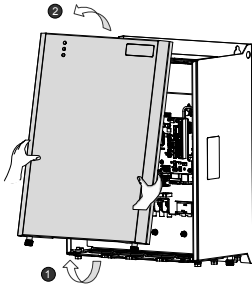

Step 2: Hold the cover with both hands and turn it up by 15° (①), push it up (②), and then take it down.

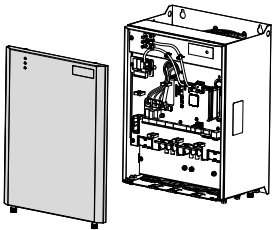

Cover removal is complete.

Cover mounting procedures

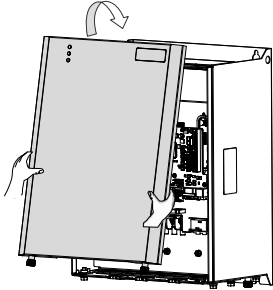

Step 1: Hold the cover with both hands, align the positioning pin at the top of the cover to the cabinet hole.

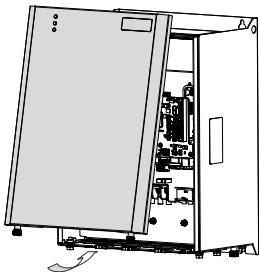

Step 2: Push down the cover by following the arrow direction shown in the figure.

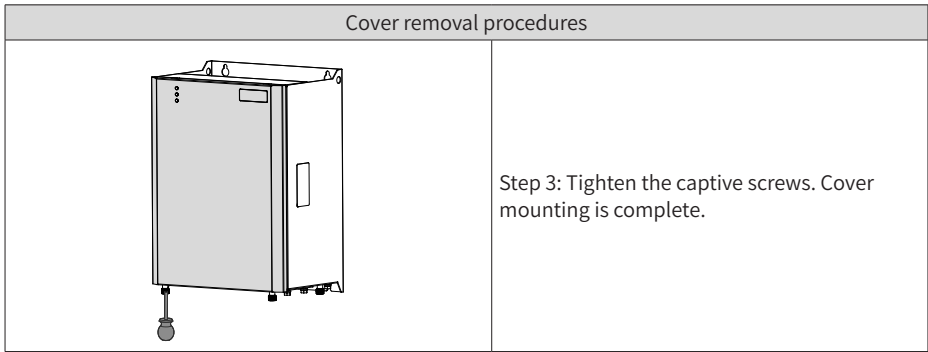

2.2 Wiring

2.2.1 Main Circuit Terminal Arrangement

Main circuit terminals adopt the bottom-in and bottom-out mode, as shown below.

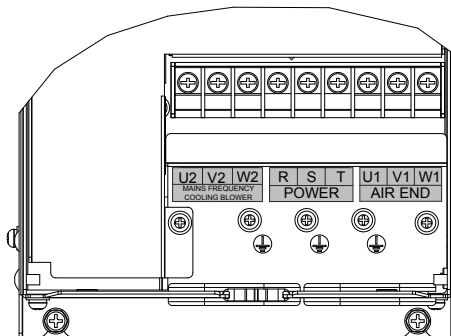

Figure 2-3 Main circuit terminal arrangement of CP700-4T5.5-H to CP700-4T7.5-H

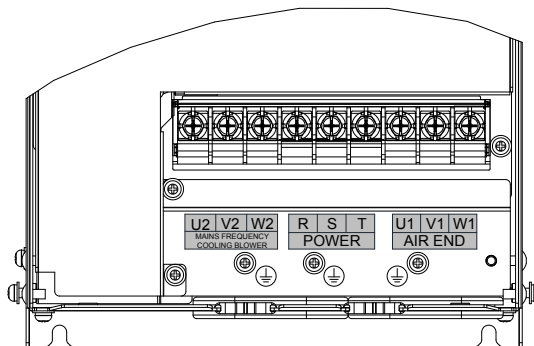

Figure 2-4 Main circuit terminal arrangement of CP700-2T7.5-H and CP700-4T11-H to CP700-4T15-H

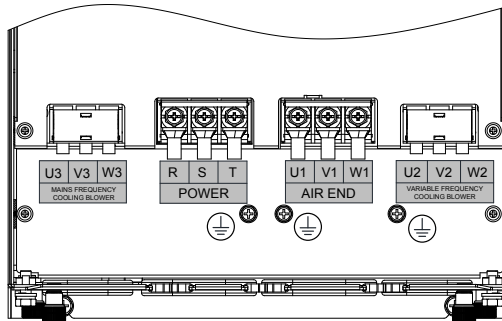

Figure 2-5 Main circuit terminal arrangement of CP700-2T11-H to CP700-2T15-H and CP700-4T18.5-H to CP700-4T22-H

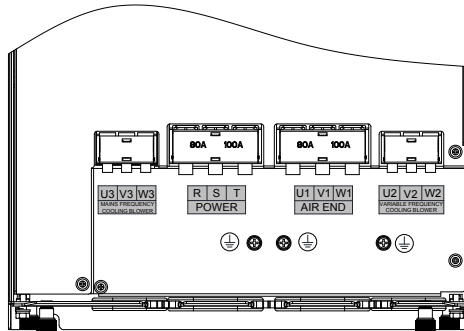

Figure 2-6 Main circuit terminal arrangement of CP700-2T18.5-H to CP700-2T22-H and CP700-4T30-H to CP700-4T37-H

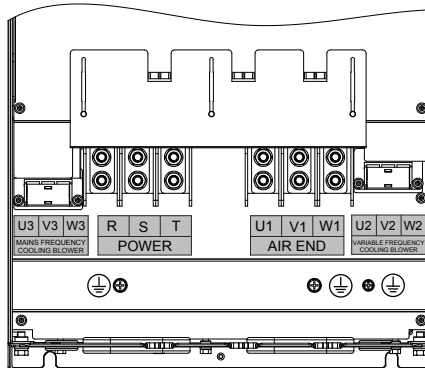



Figure 2-7 Main circuit terminal arrangement of CP700-2T30-H to CP700-2T45-H and CP700-4T45-H to CP700-4T90-H

Table 2-1 Main circuit terminal description

Terminal Symbol	Terminal Name	Function Description
R, S, and T	Input terminal	Three-phase AC input
U1, V1, and W1	Output terminal	Air end three-phase AC output
U2, V2, and W2	Mains frequency cooling blower terminal	Three phase 220 V: 7.5 kW three-phase AC output Three phase 380 V: 5.5–15 kW three-phase AC output
	Variable frequency cooling blower terminal	Three phase 380 V: 18.5–75 kW three-phase AC output
U3, V3, and W3	Mains frequency cooling blower terminal	Three phase 220 V: 11–45 kW three-phase AC output
		Three phase 380 V: 18.5–75 kW three-phase AC output
	Grounding terminal	PE grounding



NOTE

If the AC drive is used in the 480 V grid system, contact our service engineers to replace the low frequency transformer.

2.2.2 Control Terminal Arrangement

If STO board connection is required during control circuit wiring, remove the cover of the AC drive before connecting control cables. (For details, see "[2.1.3 Cover Removal and Mounting](#)".) The following figures show the control board and STO board locations.

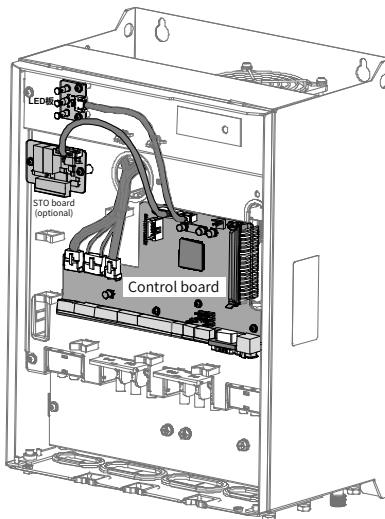

Figure 2-8 CP700 control board location

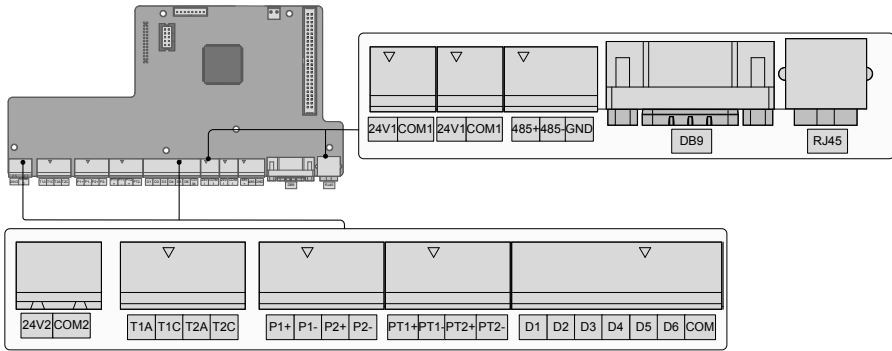

Figure 2-9 CP700 control terminal arrangement

Table 2-2 Control terminal description

Category	Terminal Symbol	Function Description	Technical Specifications
Relay output	T1A, T1C, T2A, and T2C	Relay output T1A and T1C for the solenoid valves by default	Built-in 220 VAC power supply; power capacity 50 VA; T1A-T1C supported; T2A-T2C two-way current output; total output less than 0.2 A T1A-T1C: NO T2A-T2C: NO
Pressure sensor input	P1+ and P2+	Pressure sensor power input	24 VDC, 4–20 mA input, active
	P1- and P2-	Pressure sensor signal input	
Temperature sensor input	PT1+ and PT2+	Temperature sensor PT100 input	-25°C to +220°C temperature detection with deviation of ±3°C , passive
	PT1- and PT2-		
Digital input	DI1–DI4	Common multi-function input terminals	Isolated drain input at a frequency lower than 100 Hz
	DI5–DI6	Common multi-function input terminals (PTC protection supported)	Isolated drain input at a frequency lower than 100 Hz; operation triggered when the PTC resistance is 2.3 kΩ
	COM	Common terminal of multi-function input terminals	Internally connected to GND
24V1 external power supply port	24V1	24 V power supplied in the board	24 V ± 10%; maximum output current 500 mA; touch screen power supply
	COM1	24 V power ground in the board	

2 Installation and Wiring

Category	Terminal Symbol	Function Description	Technical Specifications												
24V2 external power supply port	24V2	Independent 24 V power supply	24 V power output (optional); output current 4 A												
	COM2	Independent 24 V power supply ground													
485 communication	485+	RS485 communication+	Half duplex RS485 communication; baud rate < 230 kbps; the 485 signal terminal consistent with DB9's second 485 terminal												
	485-	RS485 communication-													
	GND	RS485 reference ground													
DB9 port	DB9	Two-channel 485 communication	<p>Standard DB9 female socket with built-in two-channel 485 communication resources Pin definition is as follows:</p> <p>Definition for the first 485 channel:</p> <table border="1"> <thead> <tr> <th>pin1</th> <th>pin2</th> <th>pin5</th> </tr> </thead> <tbody> <tr> <td>485+</td> <td>485-</td> <td>GND</td> </tr> </tbody> </table> <p>Definition for the second 485 channel:</p> <table border="1"> <thead> <tr> <th>pin5</th> <th>pin6</th> <th>pin9</th> </tr> </thead> <tbody> <tr> <td>GND</td> <td>485-</td> <td>485+</td> </tr> </tbody> </table>	pin1	pin2	pin5	485+	485-	GND	pin5	pin6	pin9	GND	485-	485+
pin1	pin2	pin5													
485+	485-	GND													
pin5	pin6	pin9													
GND	485-	485+													
RJ45	485+ and 485-	RS485 communication+ RS485 communication- Connected with the LCD panel iPanel	Half duplex RS485 communication; baud rate < 230 kbps												

2.2.3 Control Terminal Wiring

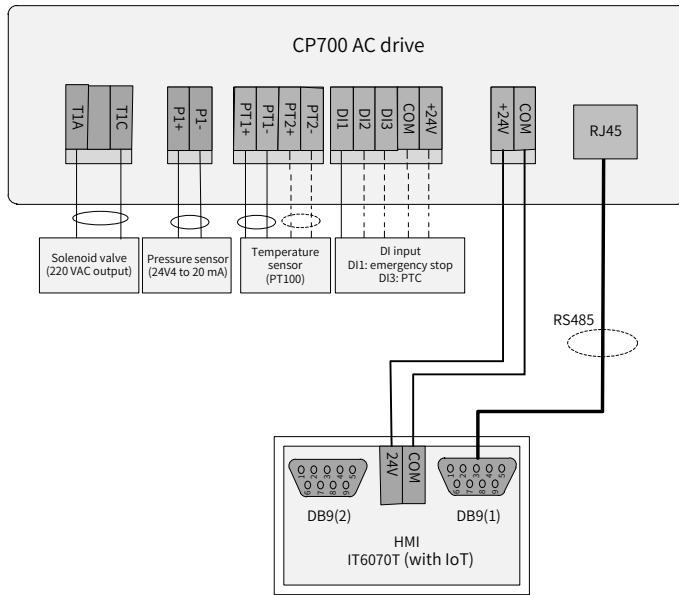

Figure 2-10 Control terminal wiring (three phase 380 V 5.5–15 kW, three phase 220 V 7.5 kW)

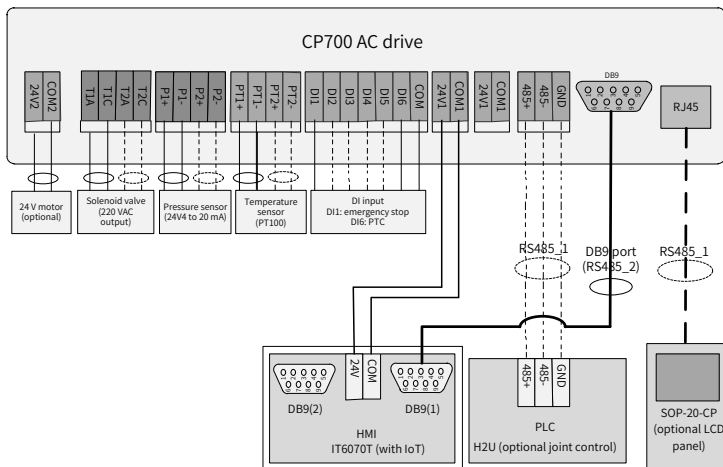

Figure 2-11 Control terminal wiring (three phase 380 V 18.5–90 kW, three phase 220 V 11–45 kW)



NOTE

In the preceding figures, solid lines indicate the recommended shortest wiring during system running, while dotted lines indicate the recommended wiring when air compressor configuration varies.

2.3 Power Grid System Requirement

The AC drive is applicable to power grid systems with neutral points grounded. If the AC drive is used in an IT power system, screw 1 shown in the following figure must be screwed out to remove the jumper of the VDR. Failure to comply may result in personal injury or damage to the AC drive.

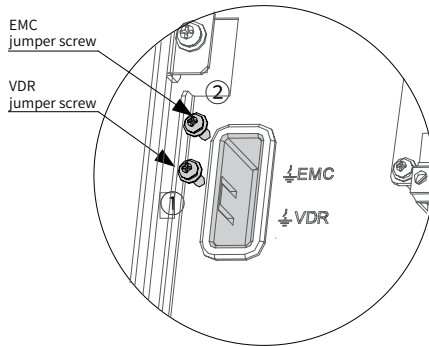

Figure 2-12 VDR and EMC grounding jumper positions

2.4 Wiring Recommendations

2.4.1 Main Power Cables

Connect main power cables as shown below. Air end input/output cables and cooling blower cables must be grounded separately.

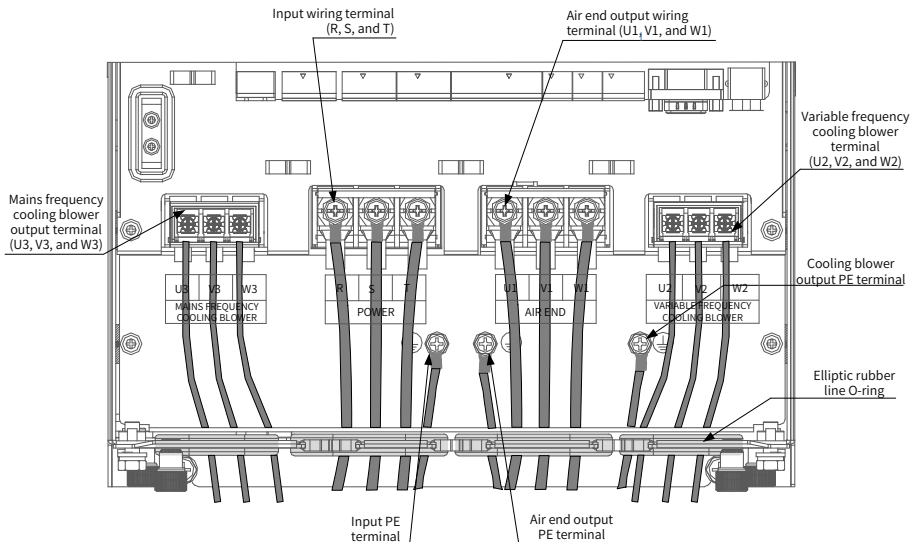

Figure 2-13 Wiring diagram of main power cables

Table 2-3 Main power cable selection requirements

AC Drive Model	Rated Input Current (A)	Input/Air end output (U1/V1/W1)		Cooling Blower Output (U2/V2/W2)		Cooling Blower Output (U3/V3/W3)		Grounding Terminal Screw/Tightening Torque (N·m)
		Recommended Cable (mm ²)	Terminal Screw/Tightening Torque	Recommended cable (mm ²)	Terminal Screw/Tightening Torque	Recommended Cable (mm ²)	Terminal Screw/Tightening Torque	
Three phase 200 VAC to 240 VAC, 50/60 Hz								
CP700-2T7.5-H	35.0	10	M5 (2.8 N·m)	0.75	M5 (2.8 N·m)	/	/	M4 (1.2 N·m)
CP700-2T11-H	49.5	16	M6 (4.8 N·m)	0.75	M4 (1.2 N·m)	0.75	M4 (1.2 N·m)	M5 (2.8 N·m)
CP700-2T15-H	60.0	16	M6 (4.8 N·m)	0.75	M4 (1.2 N·m)	0.75	M4 (1.2 N·m)	M5 (2.8 N·m)
CP700-2T18.5-H	65.0	25	M6 (4.8 N·m)	0.75	M4 (1.2 N·m)	0.75	M4 (1.2 N·m)	M5 (2.8 N·m)
CP700-2T22-H	80	25	M6 (4.8 N·m)	0.75	M4 (1.2 N·m)	0.75	M4 (1.2 N·m)	M5 (2.8 N·m)
CP700-2T30-H	120.9	50	M8 (13 N·m)	1.5	M4 (1.2 N·m)	0.75	M4 (1.2 N·m)	M6 (4.8 N·m)
CP700-2T37-H	134.0	50	M8 (13 N·m)	1.5	M4 (1.2 N·m)	0.75	M4 (1.2 N·m)	M6 (4.8 N·m)
CP700-2T45-H	159.2	70	M12 (35 N·m)	1.5	M4 (1.2 N·m)	0.75	M4 (1.2 N·m)	M8 (13 N·m)
Three phase 380 VAC to 440 VAC, 50/60 Hz								
CP700-4T5.5-H	15.9	2.5	M4 (1.2 N·m)	0.75	M4 (1.2 N·m)	/	/	M4 (1.2 N·m)
CP700-4T7.5-H	20.5	4	M4 (1.2 N·m)	0.75	M4 (1.2 N·m)	/	/	M4 (1.2 N·m)
CP700-4T11-H	26	6	M5 (2.8 N·m)	0.75	M5 (2.8 N·m)	/	/	M4 (1.2 N·m)
CP700-4T15-H	35	10	M5 (2.8 N·m)	0.75	M5 (2.8 N·m)	/	/	M4 (1.2 N·m)
CP700-4T18.5-H	47.2	10	M6 (4.8 N·m)	0.75	M4 (1.2 N·m)	0.75	M4 (1.2 N·m)	M5 (2.8 N·m)
CP700-4T22-H	57.5	16	M6 (4.8 N·m)	0.75	M4 (1.2 N·m)	0.75	M4 (1.2 N·m)	M5 (2.8 N·m)
CP700-4T30-H	65.0	16	M6 (4.8 N·m)	0.75	M4 (1.2 N·m)	0.75	M4 (1.2 N·m)	M5 (2.8 N·m)
CP700-4T37-H	80.0	25	M6 (4.8 N·m)	0.75	M4 (1.2 N·m)	0.75	M4 (1.2 N·m)	M5 (2.8 N·m)
CP700-4T45-H	101.4	35	M8 (13 N·m)	1.5	M4 (1.2 N·m)	0.75	M4 (1.2 N·m)	M6 (4.8 N·m)
CP700-4T55-H	122.3	50	M8 (13 N·m)	1.5	M4 (1.2 N·m)	0.75	M4 (1.2 N·m)	M6 (4.8 N·m)
CP700-4T75-H	164.6	70	M12 (35 N·m)	1.5	M4 (1.2 N·m)	0.75	M4 (1.2 N·m)	M8 (13 N·m)
CP700-4T90-H	186.0	95	M12 (35 N·m)	1.5	M4 (1.2 N·m)	0.75	M4 (1.2 N·m)	M8 (13 N·m)

2.4.2 Control Cables

Perform control cable wiring and main power cable wiring separately, and fasten and fix cables with a tie around the port to ensure that the connection is tight and reliable.

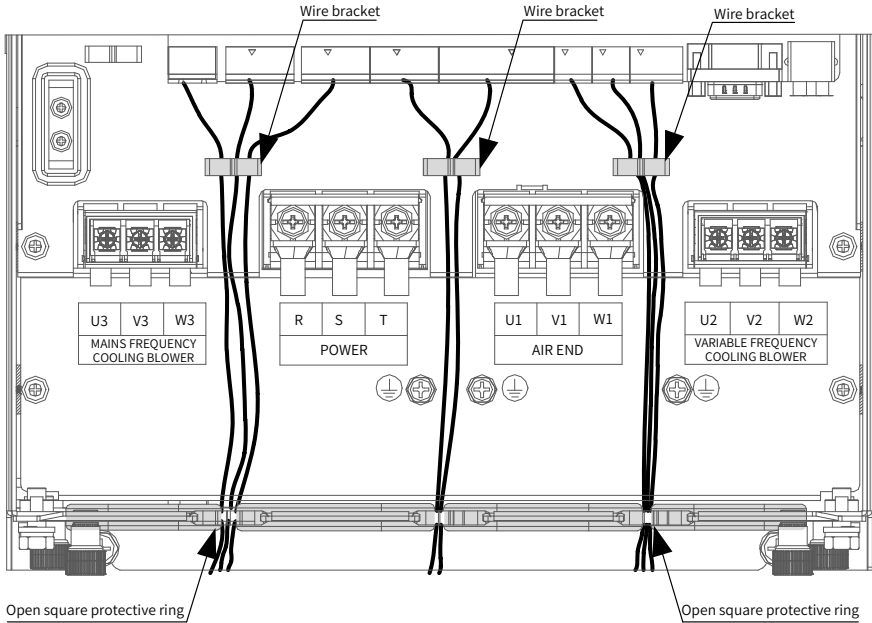

Figure 2-14 Wiring diagram of control cables

3 Display Description and Commissioning

3.1 Indicator Description

The CP700 series AC drive for air compressors has three LED indicators, indicating real-time status for power, running, and faults. Indicator positions are shown below.

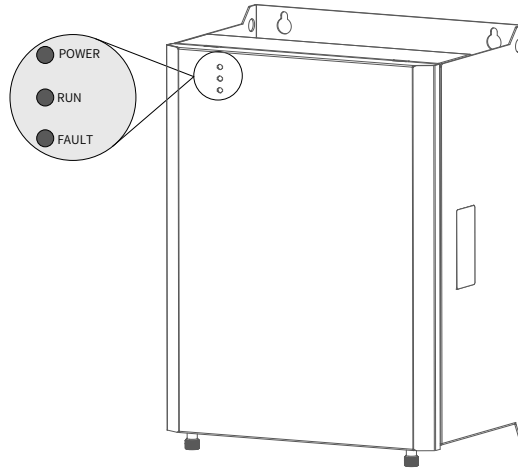

Figure 3-1 Indicator positions

Indicator Status	Status Description
Power indicators (green)	● POWER Off: power off
	☀ ● POWER On: power on
Running indicators (green)	● RUN Off: shut down
	☀ ● RUN On: running
Fault indicators (red)	● FAULT Off: normal
	☀ ● FAULT On: faulty

3.2 Commissioning Process

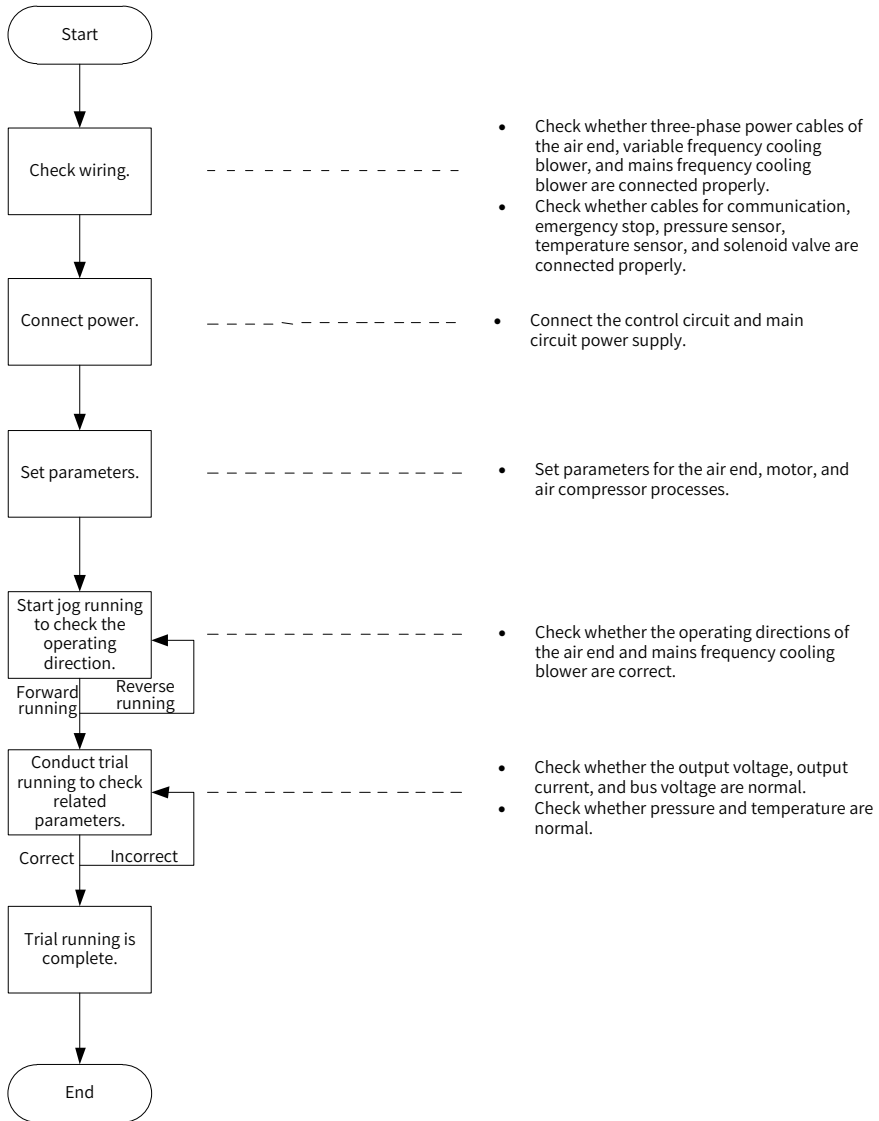

Figure 3-2 Commissioning process of the CP700 series AC drive for air compressors

3.3 System Commissioning Case Study

- 1) When power is on, HMI display automatically switches to the following page.

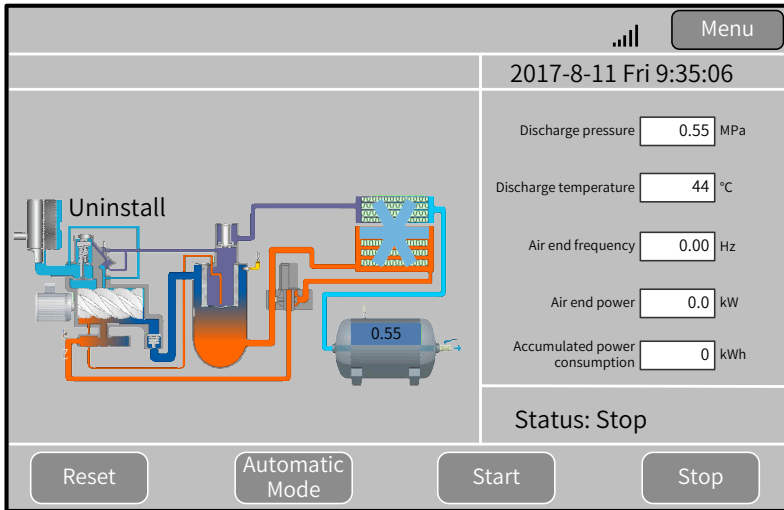

Figure 3-3 HMI main page (example)

- 2) Touch "Menu" in the upper right corner of the main page to access the page shown in Figure 3-4. Touch "Homepage", "Running Data", "User Parameters", "Maintenance Parameters", "Protection Parameters", "AC Drive Parameters", "Manufacturer Parameters", "Timing Switch", "Alarms", and "Manufacturer Information" in sequence to view more details.

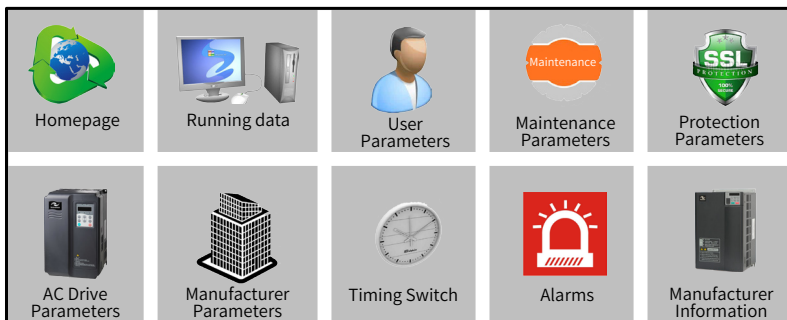

Figure 3-4 Menu (example)

- 3) Touch "User Parameters" to open the "Rights Management" dialog box for password setting.



Figure 3-5 Password setting dialog box (example)

Touch the password input box to enable the digit keypad and enter a password, as shown in Figure 3-6.



Figure 3-6 Entering a password (example)



NOTE

- ◆ After entering a correct password, touch "ENT" to open the "User Parameters" page, as shown in Figure 3-7. If an incorrect password is input, touch "CR" and enter the password again.

On the "User Parameters" page, set parameters related to the air end and cooling blower, as shown in Figure 3-7.

User Parameters		Menu		
Air end settings	Discharge pressure	0.70 MPa	Sleeping pressure	0.80 MPa
	Transition frequency	60.00 Hz	Sleep determination time	20 s
	Transition time	10 s	Sleep wake-up pressure	0.60 MPa
	Air end stop delay	3 s	Shutdown and blocking time	3 s
	Pressure (Kp)	10.0	Pressure (Ti)	0.30
Cooling blower settings	Discharge temperature	80 °C	Stopping temperature	75 °C
	Starting temperature	85 °C	Temperature (Ti)	2.00
	Temperature (Kp)	20.0		
Back				

Figure 3-7 User parameter settings (example)

- 4) Touch "Maintenance Parameters" and "Protection Parameters" in sequence to set parameters related to the air compressor.

Maintenance Parameters		Menu	
Maintenance period of air filter	2000 H	Running time of air filter	6 H
Maintenance period of lubricating oil filter	2000 H	Running time of lubricating oil filter	6 H
Maintenance period of oil and gas separator	2000 H	Running time of oil and gas separator	6 H
Maintenance period of lubricating oil	2000 H	Running time of lubricating oil	6 H
Maintenance period of motor lubricating grease	2000 H	Running time of motor lubricating grease	6 H

Figure 3-7 Maintenance parameter settings (example)

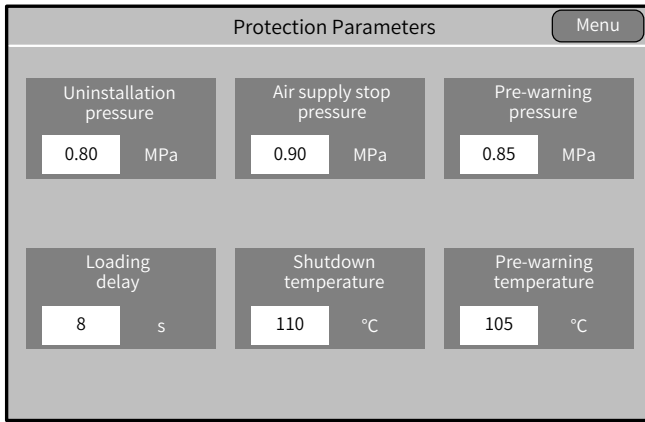

Figure 3-8 Protection parameter settings (example)

- 5) Touch "AC Drive Parameters" to set parameters.

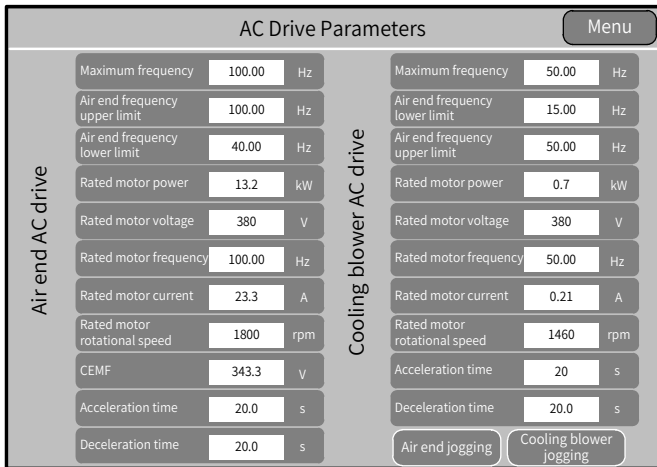

Figure 3-9 AC drive parameter settings (example)

- 6) Touch "Air End Jogging" and "Cooling Blower Jogging" respectively to conduct trial running. Observe the motor (including the air end and mains frequency cooling blower) operation direction. If the motor operates in a wrong direction, disconnect the power supply and exchange the R and S phase sequences of the motor. Then, conduct trial running again until the motor operates in the correct direction.
- 7) Touch "Start" on the homepage shown in [Figure 3-3](#) to start the air compressor. Check that the operating current and temperature are within the normal range, solenoid valve status is correct, and pressure and temperature changes are normal.
- 8) Shut down the air compressor. The commissioning is complete.

4 Troubleshooting

4.1 Fault Codes and Solutions

The following faults may occur during the use of the AC drive. Perform fault analysis according to the solutions below.

Fault Code	Fault Description	Possible Cause	Solution
Err02	Overcurrent during acceleration	9) The output circuit of the AC drive is grounded or short circuited. 10) The control mode is SVC but motor auto-tuning is not performed. 11) Acceleration time is too short under V/F control. 12) The overcurrent stall prevention parameters are set improperly for V/F control. 13) The customized torque boost or the V/F curve is improper under V/F control. 14) The motor is started during rotating. 15) The AC drive suffers external interference. 16) The motor is short-circuited to ground or between phases.	1) Eliminate external faults. Check whether short-circuit occurs on the motor or contactor. 2) Set the motor parameters according to the motor nameplate and perform motor auto-tuning. 3) Increase the acceleration time. 4) Ensure that current limit is enabled (F3-19 = 1). The setting of F3-18 (V/F current limit level) is too large. Adjust it between 120% and 150%. The setting of F3-20 (V/F current limit gain) is too small. Adjust it between 20 and 40. 5) Adjust the customized torque boost or V/F curve. 6) Select rotational speed tracking restart for the asynchronous motor or start the motor after it stops. 7) View historical fault records. If the current value is far from the overcurrent level, find the interference source. If no external interference exists, the drive board or hall device may be faulty. 8) Check whether the motor is short-circuited to ground using a multimeter.

Fault Code	Fault Description	Possible Cause	Solution
Err03	Overcurrent during deceleration	<ol style="list-style-type: none"> 1) The output circuit of the AC drive is grounded or short circuited. 2) The control mode is SVC but motor auto-tuning is not performed. 3) Acceleration time is too short under V/F control. 4) The overcurrent stall prevention parameters are set improperly for V/F control. 5) The customized torque boost or the V/F curve is improper under V/F control. 6) The motor is started during rotating. 7) The AC drive suffers external interference. 8) The motor is short-circuited to ground or between phases. 	<ol style="list-style-type: none"> 1) Eliminate external faults. Check whether short-circuit occurs on the motor or contactor. 2) Set the motor parameters according to the motor nameplate and perform motor auto-tuning. 3) Increase the acceleration time. 4) Ensure that current limit is enabled (F3-19 = 1). The setting of F3-18 (V/F current limit level) is too large. Adjust it between 120% and 150%. The setting of F3-20 (V/F current limit gain) is too small. Adjust it between 20 and 40. 5) Adjust the customized torque boost or V/F curve. 6) Select rotational speed tracking restart for the asynchronous motor or start the motor after it stops. 7) View historical fault records. If the current value is far from the overcurrent level, find the interference source. If no external interference exists, the drive board or hall device may be faulty. 8) Check whether the motor is short-circuited to ground using a multimeter.

Fault Code	Fault Description	Possible Cause	Solution
Err04	Overcurrent at constant speed	<ol style="list-style-type: none"> 1) The output circuit of the AC drive is grounded or short circuited. 2) The control mode is SVC but motor auto-tuning is not performed. 3) Acceleration time is too short under V/F control. 4) The overcurrent stall prevention parameters are set improperly for V/F control. 5) The customized torque boost or the V/F curve is improper under V/F control. 6) The motor is started during rotating. 7) The AC drive suffers external interference. 8) The motor is short-circuited to ground or between phases. 	<ol style="list-style-type: none"> 1) Eliminate external faults. Check whether short-circuit occurs on the motor or contactor. 2) Set the motor parameters according to the motor nameplate and perform motor auto-tuning. 3) Increase the acceleration time. 4) Ensure that current limit is enabled (F3-19 = 1). The setting of F3-18 (V/F current limit level) is too large. Adjust it between 120% and 150%. The setting of F3-20 (V/F current limit gain) is too small. Adjust it between 20 and 40. 5) Adjust the customized torque boost or V/F curve. 6) Select rotational speed tracking restart for the asynchronous motor or start the motor after it stops. 7) View historical fault records. If the current value is far from the overcurrent level, find the interference source. If no external interference exists, the drive board or hall device may be faulty. 8) Check whether the motor is short-circuited to ground using a multimeter.
Err05	Overvoltage during acceleration	<ol style="list-style-type: none"> 1) The input voltage is too high. 2) An external force drives the motor during acceleration. 3) The overvoltage stall prevention parameters are set improperly. 4) The acceleration time is too short. 	<ol style="list-style-type: none"> 1) Adjust the voltage to the normal range. 2) Cancel the external force. 3) Check that the voltage limit function is enabled (F3-23 = 1). If the setting of F3-22 (V/F voltage limit) is too large, adjust it between 700 V and 770 V. If the setting of F3-24 (V/F frequency gain for voltage limit) is too small, adjust it between 30 and 50. 4) Increase the acceleration time.

Fault Code	Fault Description	Possible Cause	Solution
Err06	Overvoltage during deceleration	<ol style="list-style-type: none"> 1) The overvoltage stall prevention parameters are set improperly. 2) An external force drives the motor during deceleration. 3) The deceleration time is too short. 	<ol style="list-style-type: none"> 1) Check that the voltage limit function is enabled (F3-23 = 1). If the setting of F3-22 (V/F voltage limit) is too large, adjust it between 700 V and 770 V. If the setting of F3-24 (V/F frequency gain for voltage limit) is too small, adjust it between 30 and 50. 2) Cancel the external force or install a braking resistor. 3) Increase the deceleration time.
Err07	Overvoltage at constant speed	<ol style="list-style-type: none"> 1) The overvoltage stall prevention parameters are set improperly. 2) An external force drives the motor during acceleration. 3) The input voltage fluctuates greatly in the field. 	<ol style="list-style-type: none"> 1) Check that the voltage limit function is enabled (F3-23 = 1). If the setting of F3-22 (V/F voltage limit) is too large, adjust it between 700 V and 770 V. If the setting of F3-24 (V/F frequency gain for voltage limit) is too small, adjust it between 30 and 50. If the setting of F3-26 (V/F frequency rise threshold during voltage limit) is too small. Adjust it between 5 Hz and 20 Hz. 2) Cancel the external force. 3) Adjust the input voltage fluctuation range to an allowed range.
Err09	Undervoltage	<ol style="list-style-type: none"> 1) Instantaneous power failure occurs. 2) The AC drive's input voltage is not within the allowable range. 3) The bus voltage is abnormal. 4) The rectifier bridge, snubber resistor, drive board, or the control board is abnormal. 	<ol style="list-style-type: none"> 1) Enable the power dip ride through function (F9-59 ≠ 0). 2) Adjust the voltage to the normal range. 3) Contact the agent or Inovance for technical support. 4) Contact the agent or Inovance for technical support.

Fault Code	Fault Description	Possible Cause	Solution
Err10	AC drive overload	<ol style="list-style-type: none"> 1) The load is too heavy or locked-rotor occurs on the motor. 2) The AC drive model is of too low power rating. 3) The air end of the air compressor rotates in the reverse direction. 	<ol style="list-style-type: none"> 1) Reduce the load and check the motor and mechanical conditions. 2) Select an AC drive of higher power rating. 3) Check that the motor wiring is correct.
Err11	Motor overload	<ol style="list-style-type: none"> 1) F9-01 (Motor overload protection gain) is set improperly. 2) The load is too heavy or locked-rotor occurs on the motor. 	<ol style="list-style-type: none"> 1) Set F9-01 (Motor overload protection gain) properly. 2) Reduce the load and check the motor and mechanical conditions.
Err12	Input phase loss	<ol style="list-style-type: none"> 1) The three-phase power input is abnormal. 2) The drive board, lightning protection board, control board, or rectifier bridge is abnormal. 	<ol style="list-style-type: none"> 1) Eliminate external faults. 2) Contact the agent or Inovance for technical support.
Err13	Output phase loss	<ol style="list-style-type: none"> 1) The motor is faulty. 2) The cables connecting the AC drive and the motor are abnormal. 3) The three-phase outputs of the AC drive are unbalanced when the motor is running. 4) The drive board or the IGBT is abnormal. 	<ol style="list-style-type: none"> 1) Check whether the motor is disconnected. 2) Eliminate external faults. 3) Check whether the motor three-phase winding is normal. 4) Contact the agent or Inovance for technical support.
Err14	IGBT overheat	<ol style="list-style-type: none"> 1) The ambient temperature is too high. 2) The air filter is blocked. 3) The fan is damaged. 4) The thermistor of the IGBT is damaged. 5) The IGBT is damaged. 	<ol style="list-style-type: none"> 1) Reduce the ambient temperature. 2) Clean the air filter. 3) Replace the damaged fan. 4) Replace the damaged thermistor. 5) Replace the damaged IGBT.
Err15	External device fault	External fault signals are input using the DI.	Confirm that the mechanical condition allows restart (F8-18) and reset the operation.

Fault Code	Fault Description	Possible Cause	Solution
Err16	Communication fault	<ol style="list-style-type: none"> 1) The host computer is abnormal. 2) The communication cable is faulty. 3) F0-28 (Auxiliary frequency coefficient) is set improperly for the communication extension card. 4) Communication parameters in group FD are set improperly. 	<ol style="list-style-type: none"> 1) Check wiring of the host computer. 2) Check connection of the communication cable. 3) Set the communication extension card type correctly. 4) Set communication parameters in group FD properly. After all the preceding solutions are done but the fault still exists, restore the default settings.
Err17	Contactor fault	<ol style="list-style-type: none"> 1) The drive board and power supply are abnormal. 2) The contactor is abnormal. 3) The lightning protection board is abnormal. 	<ol style="list-style-type: none"> 1) Replace the faulty drive board or power supply board. 2) Replace the faulty contactor. 3) Replace the lightning protection board.
Err18	Current detection fault	<ol style="list-style-type: none"> 1) The hall is abnormal. 2) The drive board is abnormal. 	<ol style="list-style-type: none"> 1) Replace the hall device. 2) Replace the drive board.
Err19	Motor auto-tuning fault	<ol style="list-style-type: none"> 1) The motor parameters are not set according to the nameplate. 2) Motor auto-tuning times out. 	<ol style="list-style-type: none"> 1) Set the motor parameters according to the nameplate properly. 2) Check the cables connecting the AC drive and the motor.
Err21	EEPROM read-write fault	The EEPROM chip is damaged.	Replace the main control board.
Err23	Short circuit to ground	The motor is short circuited to the ground.	Replace the cable or motor.
Err26	Accumulative running time reached	The accumulative running time reaches the setting value.	Clear the record through parameter initialization.
Err29	Accumulative power-on time reached	The accumulative power-on time reaches the setting value.	Clear the record through parameter initialization.
Err40	Pulse-by-pulse current limit fault	<ol style="list-style-type: none"> 1) The load is too heavy or locked-rotor occurs on the motor. 2) The AC drive model is of too low power rating. 	<ol style="list-style-type: none"> 1) Reduce the load and check the motor and mechanical conditions. 2) Select an AC drive of higher power rating.

Fault Code	Fault Description	Possible Cause	Solution
Err42	Large speed error	<ol style="list-style-type: none"> 1) Motor auto-tuning is not performed. 2) F9-69 (Detection level of speed error) and F9-70 (Detection time of speed error) are set improperly. 3) The load is too heavy. 	<ol style="list-style-type: none"> 1) Perform motor auto-tuning. 2) Set F9-69 (Detection level of speed error) and F9-70 (Detection time of speed error) correctly based on actual conditions. 3) Select an AC drive properly.
Err45	Motor overtemperature	<ol style="list-style-type: none"> 1) Cable connection of the temperature sensor becomes loose. 2) The motor temperature is too high. 	<ol style="list-style-type: none"> 1) Check cable connection of the temperature sensor. 2) Increase the carrier frequency or take other measures to cool the motor.
A65	Pre-warning of pressure sensor 2	<ol style="list-style-type: none"> 1) The pressure sensor is connected with the temperature sensor cable by mistake. 2) The setting of P2 pressure range does not meet requirements of the pressure sensor. 3) A8-10 [Stop pressure setting value (protection pressure)] and A8-11 (Pre-warning pressure setting value) are set to small values. 4) The pressure sensor is abnormal. 	<ol style="list-style-type: none"> 1) Connect the pressure sensor cable correctly. 2) Set the P2 pressure range according to the requirements of the pressure sensor. 3) Set A8-10 [Stop pressure setting value (protection pressure)] and A8-11 (Pre-warning pressure setting value) based on actual requirements. 4) Replace the faulty pressure sensor.
Err66	Overpressure of pressure sensor 2		
Err67	Overtemperature of temperature sensor 2	<ol style="list-style-type: none"> 1) The temperature sensor is connected with the pressure sensor cable by mistake. 	<ol style="list-style-type: none"> 1) Connect the temperature sensor cable correctly.
A68	Pre-warning of temperature sensor 2	<ol style="list-style-type: none"> 2) The sensor temperature is too high due to poor heat dissipation. 	<ol style="list-style-type: none"> 2) Check whether the air filter is clogged and the cooling fan rotates in the reverse direction.

Fault Code	Fault Description	Possible Cause	Solution
A70	Pre-warning of pressure sensor 1	1) The pressure sensor is connected with the temperature sensor cable by mistake. 2) The setting of P2 pressure range does not meet requirements of the pressure sensor. 3) A8-10 [Stop pressure setting value (protection pressure)] and A8-11 (Pre-warning pressure setting value) are set to small values. 4) The pressure sensor is abnormal.	1) Connect the pressure sensor cable correctly. 2) Set the P2 pressure range according to the requirements of the pressure sensor. 3) Set A8-10 [Stop pressure setting value (protection pressure)] and A8-11 (Pre-warning pressure setting value) based on actual requirements. 4) Replace the faulty pressure sensor.
Err71	Overpressure of pressure sensor 1		
Err72	Overtemperature of temperature sensor 1	1) The temperature sensor is connected with the pressure sensor cable by mistake.	1) Connect the temperature sensor cable correctly.
A73	Pre-warning of temperature sensor 1	2) The sensor temperature is too high due to poor heat dissipation.	2) Check whether the air filter is clogged and the cooling fan rotates in the reverse direction.
Err74	Pressure sensor disconnection fault	1) The pressure sensor wiring is abnormal.	1) Check the wiring.
Err75	Temperature sensor disconnection fault	2) The pressure or temperature sensor is abnormal.	2) Replace the faulty pressure or temperature sensor.
A76	Air filter maintenance pre-warning	The value of A8-28 (Air filter running time) reaches that of A8-23 (Air filter maintenance setting time) in maintenance parameters.	Maintain the air filter and clear A8-28 (Air filter running time).
A77	Oil filter maintenance pre-warning	The value of A8-29 (Oil filter running time) reaches that of A8-24 (Oil filter maintenance setting time) in maintenance parameters.	Maintain the oil filter and clear A8-29 (Oil filter running time).
A78	Oil/Gas separation maintenance pre-warning	The value of A8-30 (Oil gas separating running time) reaches that of A8-25 (Oil gas separating maintenance setting time) in maintenance parameters.	Maintain the oil and gas separator and clear A8-30 (Oil gas separating running time).

Fault Code	Fault Description	Possible Cause	Solution
A79	Motor lubricating grease maintenance pre-warning	The value of A8-31 (Motor lubricating grease running time) reaches that of A8-26 (Motor lubricating grease maintenance setting time) in maintenance parameters.	Apply the lubricating grease and clear A8-31 (Motor lubricating grease running time).
Err80	Lubricating oil maintenance pre-warning	The value of A8-32 (Lubricating oil applying time) reaches that of A8-27 (Lubricant maintenance setting time) in maintenance parameters.	Apply the lubricating oil and clear A8-32 (Lubricating oil applying time).
Err81	PTC2 overtemperature	The PTC thermistor is disconnected due to motor overtemperature. The DI terminal detects that the motor PTC signal is disconnected.	<ol style="list-style-type: none"> 1) Check the wiring. PTC2 indicates the cooling blower PTC, which must be connected to DI5 with function 58 and COM. If no cooling blower PTC is available, DI5 is allocated with function 0. 2) Check whether motor overtemperature exists. Check the cooling blower motor. 3) Check whether the cooling blower PTC is damaged. Check whether the PTC resistance is less than 3 kΩ independently. 4) Short DI5 and COM or allocate DI5 with function 0 temperately to disable PTC2.
Err82	Oil fine separator blocked	<ol style="list-style-type: none"> 1) The oil fine separator is blocked. 2) The DI terminal setting and wiring are incorrect. 	<ol style="list-style-type: none"> 1) Clean the oil fine separator. 2) Check the DI terminal function setting and wiring.
Err83	Separator blocked	<ol style="list-style-type: none"> 1) The separator is blocked. 2) The DI terminal setting and wiring are incorrect. 	<ol style="list-style-type: none"> 1) Clean the separator. 2) Check the DI terminal function setting and wiring.
Err84	Oil filter blocked	<ol style="list-style-type: none"> 1) The oil filter is blocked. 2) The DI terminal setting and wiring are incorrect. 	<ol style="list-style-type: none"> 1) Clean the oil filter. 2) Check the DI terminal function setting and wiring.
Err85	Air filter blocked	<ol style="list-style-type: none"> 1) The air filter of the oil fine separator is blocked. 2) The DI terminal setting and wiring are incorrect. 	<ol style="list-style-type: none"> 1) Clean the air filter. 2) Check the DI terminal function setting and wiring.

Fault Code	Fault Description	Possible Cause	Solution
Err86	PTC overtemperature	The PTC thermistor is disconnected due to motor overtemperature. The DI terminal detects that the motor PTC signal is disconnected.	<ol style="list-style-type: none"> 1) Check the wiring. PTC indicates the main motor PTC, which must be connected to DI6 with function 57 and COM. If no main motor PTC is available, DI6 is allocated with function 0. 2) Check whether motor overtemperature exists. Check heat dissipation of the main motor. 3) Check whether the main motor PTC is damaged. Check whether the PTC resistance is less than 3 kΩ independently. Short DI6 and COM or allocate DI6 with function 0 temperately to disable PTC.
A87	Limited running time pre-warning	The running time reaches the set limited running time.	Clear the running time or disable the limited running function.
Err88	Stop for air filter maintenance	Air filter running time - Air filter maintenance period \geq Long-time stop pre-warning time	<ol style="list-style-type: none"> 1) Maintain the equipment and clear related running time. 2) Contact the agent or Inovance for technical support.
Err89	Stop for oil filter maintenance	Oil filter running time - Oil filter maintenance period \geq Long-time stop pre-warning time	<ol style="list-style-type: none"> 1) Maintain the equipment and clear related running time. 2) Contact the agent or Inovance for technical support.
Err90	Stop for oil/gas separation maintenance	Oil/gas separator running time - Oil/gas separator maintenance period \geq Long-time stop pre-warning time	<ol style="list-style-type: none"> 1) Maintain the equipment and clear related running time. 2) Contact the agent or Inovance for technical support.
Err91	Stop for motor lubricating grease maintenance	Lubricating grease applying time - Lubricating grease maintenance period \geq Long-time stop pre-warning time	<ol style="list-style-type: none"> 1) Maintain the equipment and clear related running time. 2) Contact the agent or Inovance for technical support.
Err92	Stop for lubricating oil maintenance	Lubricating oil applying time - Lubricating oil maintenance period \geq Long-time stop pre-warning time	<ol style="list-style-type: none"> 1) Maintain the equipment and clear related running time. 2) Contact the agent or Inovance for technical support.
Err93	Stop after pressure pre-warning time exceeded	Duration from the pressure pre-warning reported \geq Long-time stop pre-warning time	See the solutions for A70/71.

Fault Code	Fault Description	Possible Cause	Solution
Err94	Stop after temperature pre-warning time exceeded	Duration from the temperature pre-warning reported \geq Long-time stop pre-warning time	See the solutions for Err72/A73.
Err95	Solenoid valve overcurrent	<ol style="list-style-type: none"> 1) The model and specifications of the solenoid valve are not suitable for the transformer. 2) The solenoid valve is broken. 3) When the AC drive is running with load, the TA/TC terminal has no 220 V output. 	<ol style="list-style-type: none"> 1) Check whether the model and specifications of the solenoid valve are suitable for the transformer (AC 110/220 V). 2) Replace the solenoid valve. 3) Contact the agent or Inovance for technical support.
Err96	Phase sequence abnormal	Three-phase input sequence abnormal (R, S, T)	Exchange any two of the phase sequences.
Err97	Output phase loss of mains frequency cooling blower	<ol style="list-style-type: none"> 1) The motor wiring is incorrect. 2) The motor cooling blower is damaged. 3) The fuse is loose or damaged. 	<ol style="list-style-type: none"> 1) Wire the motor properly. 2) Use a multimeter to measure the resistance between phases. If open circuit exists, replace the motor cooling blower. 3) Fix the fuse properly or replace the fuse.
Err98	Low pump pressure	<ol style="list-style-type: none"> 1) The water pump function is not provided, and the DI terminal is allocated with function 59. 2) The water pump function is provided, and the DI terminal is allocated with function 59. 	<ol style="list-style-type: none"> 1) Allocate the DI terminal with function 0. 2) If the water pump is abnormal, repair or replace it.
Err99	Mains frequency cooling blower overload	<ol style="list-style-type: none"> 1) The mains frequency cooling blower is with high specifications. 2) The motor cooling blower is blocked or stuck with a foreign matter. 	<ol style="list-style-type: none"> 1) Select a suitable cooling blower. 2) Clear the foreign matter.

4.2 Symptoms and Solutions

No.	Fault Symptom	Possible Cause	Possible Solution
1	There is no display while power-on.	There is no power supply to the AC drive or the power input to the AC drive is too low.	Check the power supply.
		The switching power supply on the drive board of the AC drive is faulty.	Check the bus voltage.
		The cable connecting the control board and the drive board and the operating panel is broken.	Re-connect the 8-pin wire and 40-pin wire.
		The pre-charge resistor of the AC drive is damaged.	Contact the agent or Inovance for technical support.
		The control board or operating panel is faulty.	
The rectifier bridge is damaged.			
2	"HC" is displayed while power-on.	The cable connecting the drive board and the control board is in poor contact.	Re-connect the 8-pin wire and 28-pin wire.
		Related components on the control board are damaged.	Contact the agent or Inovance for technical support.
		The motor or motor cable is short circuited to the ground.	
		The hall is damaged.	
		The grid voltage is too low.	
3	"Err23" is displayed while power-on.	The motor or motor cable is short circuited to the ground.	Use an insulation tester to measure the insulation resistance of the motor and motor cable.
		The AC drive is damaged.	Contact the agent or Inovance for technical support.
4	The display is normal while power-on. But after running, "HC" is displayed and the AC drive stops immediately.	The cooling fan is damaged or locked-rotor occurs.	Replace the damaged fan.
		The cable of the external control terminal is short circuited.	Eliminate the external short-circuit fault.
5	"Err14" (IGBT overheat) is detected frequently.	The setting of carrier frequency is too high.	1. Reduce F0-15 (Carrier frequency).
		The cooling fan is damaged, or ventilation is clogged.	Replace the fan or clean the ventilation.
		Components inside the AC drive are damaged (thermistor or others).	Contact the agent or Inovance for technical support.

No.	Fault Symptom	Possible Cause	Possible Solution
6	The motor does not rotate after the AC drive runs.	The motor and motor cable are in poor contact.	Check that the wiring between the AC drive and motor is normal.
		Related AC drive parameters (motor parameters) are set improperly.	Restore the factory parameters and reset related parameters properly. Check that the rated motor parameters are set properly, including rated motor frequency and rated motor speed. Check that F0-01 (Motor 1 control mode) and F0-02 (Command source selection) are set properly. Modify F3-01 (Torque boost) in V/F control mode under heavy-load start.
		The cable connecting the drive board and control board is in poor contact.	Re-connect wirings and ensure secure connection.
		The drive board is faulty.	Contact the agent or Inovance for technical support.
7	DI terminals are disabled.	Related parameters are incorrectly set.	Check and set the parameters in group F4 again.
		External signals are incorrect.	Re-connect external signal cables.
		The jumper across OP and +24 V becomes loose.	Re-confirm the jumper across OP and +24 V.
		The control board is faulty.	Contact the agent or Inovance for technical support.
8	The motor speed does not rise in FVC mode.	The drive board is faulty.	Contact the agent or Inovance for technical support.
9	The AC drive detects overcurrent and overvoltage frequently.	Motor parameters are set improperly.	Reset motor parameters or perform motor auto-tuning.
		The acceleration/deceleration time is improper.	Set proper acceleration/deceleration time.
		The load fluctuates.	Contact the agent or Inovance.
10	"Err17" is reported while power-on (or during running).	The soft startup contactor is not closed.	Check whether the contactor cable is loose. Check whether the contactor is faulty. Check whether 24 V power supply of the contactor is faulty. Contact the agent or Inovance for technical support.

5 Maintenance

5.1 Daily Maintenance

Check the following items daily to avoid deterioration in performance or products. Copy this checklist and sign the "checked" column after each inspection.

Inspection Item	Inspection Details	Checked
Installation Environment	<ul style="list-style-type: none"> ◆ Check whether the ambient temperature, humidity and vibration are within the permissible range. ◆ Check whether the AC drive is installed in an environment without dust, combustible and explosive gases, oil mist, and water drops. 	
Electric cabinet	<ul style="list-style-type: none"> ◆ Check whether the mounting bracket is loose. ◆ Check whether copper ground bars and terminals become loose or get corroded. 	
Motor	<ul style="list-style-type: none"> ◆ Check whether abnormal noise exists. ◆ Check whether abnormal oscillation exists. ◆ Check whether the connection between the motor and AC drive becomes loose. ◆ Check whether the motor fixing screws become loose. 	
Cooling fan	<ul style="list-style-type: none"> ◆ Check whether abnormal noise or vibration exists on the cooling fan of the AC drive. ◆ Check whether abnormal noise or vibration exists on the cooling fan of the motor. 	
Load	<ul style="list-style-type: none"> ◆ Check whether the motor parameters are set properly. ◆ Check whether the motor is overload. ◆ Check for mechanical vibration (< 1G under normal conditions). 	
Voltage	<ul style="list-style-type: none"> ◆ Check whether the main circuit voltage is within the permissible range. ◆ Check whether the control circuit voltage is normal. ◆ Check whether start of heavy load exists. 	
Operating panel	<ul style="list-style-type: none"> ◆ Check whether the operating panel display is clear. ◆ Check whether any character disappears. 	
Main circuit	<ul style="list-style-type: none"> ◆ Check whether any screw is loose. 	
Filter capacitor	<ul style="list-style-type: none"> ◆ Check whether liquid leakage, discoloring, cracking, or housing expansion occurs on the filter capacitor. 	
Electromagnetic contactor	<ul style="list-style-type: none"> ◆ Check whether the contactor is loose or abnormal noise exists during operation. ◆ Check whether short-circuit, water stain, expansion, or cracking occurs on external components. 	

5.2 Periodic Inspection

Inspection Item	Inspection Details	Inspection Method and Troubleshooting	Inspection Period	Checked
Mechanical components	Check whether abnormal noise or vibration exists. Check whether fasteners such as screws are loose. Check whether deformation or damage occurs. Check whether discoloring occurs due to overheat. Check whether dust or de-facement exists.	<ul style="list-style-type: none"> ◆ Check by observing and hearing. ◆ Tighten fasteners. ◆ Replace the deformed or damaged component. ◆ Clean dust with a vacuum cleaner, and wipe surface dirt gently with a soft cloth immersed in neutral detergent. 	Half a year	
Cables	Check whether discoloration exists on the cables and connections. Check the cable insulation layer for aging or wear.	<ul style="list-style-type: none"> ◆ Replace cracked cables. ◆ Replace damaged terminals. 	Half a year	
Air filter	Check whether the air filter and heatsink are clogged or stuck with any foreign matter. Check whether the air inlet and outlet are clogged or stuck with any foreign matter.	<ul style="list-style-type: none"> ◆ Clean the air filter and heatsink. ◆ Clean the air inlet and outlet. 	Half a year	
Control circuit	Check whether control components are in poor contact. Check whether terminal screws are loose. Check whether control cable insulation is cracked.	<ul style="list-style-type: none"> ◆ Clear away foreign matters on the surface of control cables and connection terminals. ◆ Replace damaged or corroded control cables. 	Half a year	

5.3 Replacement of Wear Parts

5.3.1 Lifetime of Wear Parts

Wear parts of the AC drive include the cooling fan and filter electrolytic capacitor. Their lifetime is related to the operating environment and maintenance. The lifetime of the two components under general conditions is listed as below.

Component	Lifetime ^[1]
Cooling fan	≥ 5 years
Electrolytic capacitor	≥ 5 years

**NOTE**

[1] The standard lifetime indicates the lifetime when the components are used in the following conditions. You can determine when to replace these components according to the actual operating time.

- 1) Ambient temperature: 40°C
- 2) Load rate: 80%
- 3) Operating rate: 24 hours per day

5.3.2 Number of Cooling Fans

Model	Number of Cooling Fans
CP700-2T7.5-H	2
CP700-2T11-H	1
CP700-2T15-H	1
CP700-2T18.5-H	1
CP700-2T22-H	1
CP700-2T30-H	2
CP700-2T37-H	2
CP700-2T45-H	2
CP700-4T5.5-H	1
CP700-4T7.5-H	1
CP700-4T11-H	2
CP700-4T15-H	2
CP700-4T18.5-H	1
CP700-4T22-H	1
CP700-4T30-H	1
CP700-4T37-H	1
CP700-4T55-H	2
CP700-4T75-H	2
CP700-4T90-H	2

5.3 Replacing Cooling Fans

- 1) Possible damage causes: bearing worn and blade aging
- 2) Judging criteria: whether there is crack on the blade; whether there is abnormal vibration noise upon startup; whether the blade runs abnormally
- 3) Removal and installation:
 - Press the fan cover hook and pull the fan outward.

- After replacement is completed, check that the air flow direction is upright.

Removing the Fan (CP700-4T5.5-H to CP700-4T7.5-H)

- 1) Disconnect the fan power cable. (Top view)

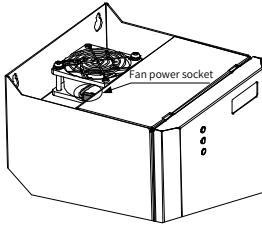

- 2) Remove the two screws from the fan cover using a screwdriver.

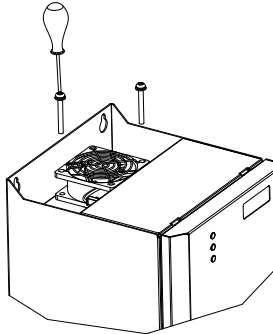

- 3) Remove the fan and fan cover from the AC drive.

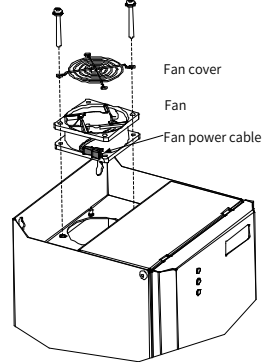

Mounting the Fan (CP700-4T5.5-H to CP700-4T7.5-H)

- 1) Install the fan in a reverse procedure to removal.
- 2) Pay attention to the direction of the fan. Note that the airflow direction arrow (on the side of the fan) must be upright after the fan is installed.
- 3) Install the fan and fan cover on the AC drive. Align the mounting holes of the cooling fan, fan cover and the AC drive, as shown in figure 3 of the removal procedure.
- 4) After replacement is completed, check that the air flow direction is upright.

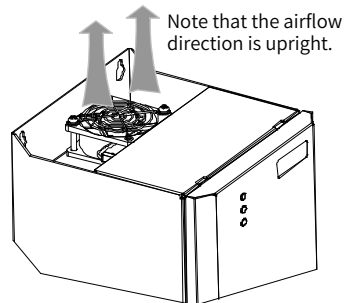
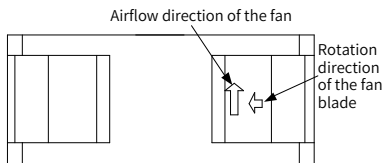

NOTE

The fan removal and installation methods for models with only one cooling fan (CP700-2T11-H to CP700-2T22-H and CP700-4T18.5-H to CP700-4T37-H) are similar to those for models CP700-4T5.5-H to CP700-4T7.5-H. However, you need to remove four screws in step 2 of the removal procedure.

Removing the Fan (CP700-4T11-H to CP700-4T15-H)

- 1) Disconnect the fan power cable. (Top view)

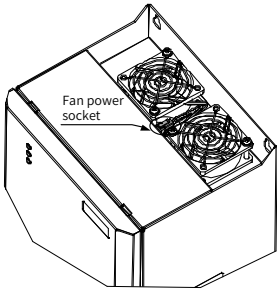

- 2) Remove the four screws from the fan cover using a screwdriver.

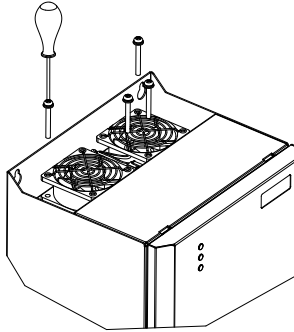

- 3) Remove the fan and fan cover from the AC drive.

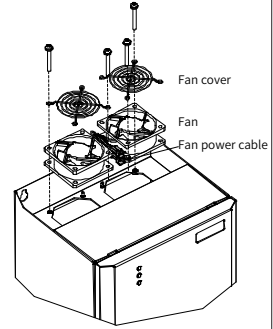

Mounting the Fan (CP700-4T11-H to CP700-4T15-H)

- 1) Install the fan in a reverse procedure to removal.
- 2) Pay attention to the direction of the fan. Note that the airflow direction arrow (on the side of the fan) must be upright after the fan is installed.
- 3) Install the fan and fan cover on the AC drive. Align the mounting holes of the cooling fan, fan cover and the AC drive, as shown in figure 3 of the removal procedure.
- 4) After replacement is completed, check that the air flow direction is upright.

Note that the airflow direction is upright.

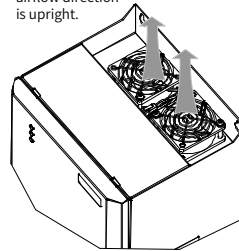
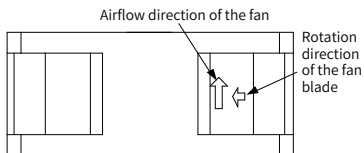

The fan removal and installation methods for models with two cooling fans (CP700-2T7.5, CP700-2T30-H to CP700-2T45-H, and CP700-4T55-H to CP700-4T90-H) are similar to those for models CP700-4T11-H to CP700-4T15-H.

5.4 Storage

For storage of the AC drive, pay attention to the following three aspects:

- 1) Pack the AC drive with the original packing box provided by Inovance.
- 2) Do not expose the AC drive to moisture, high temperature, or outdoor direct sunlight for a long time.
- 3) The electrolytic capacitor will deteriorate after being stored for a long time. Therefore, the AC drive must be switched on once for at least 5 hours every 6 months. The input voltage must be increased slowly to the rated value by using a voltage regulator.

Appendix A Parameter Table

☆ : The parameter can be modified when the AC drive is in either stop or running state.

★ : The parameter cannot be modified when the AC drive is in the running state.

● : The parameter is the actual measured value and cannot be modified.

*: The parameter is a factory parameter and can be set only by the manufacturer.

A.1 Standard Parameter Table

Param. No.	Param. Name	Setting Range	Default	Property
Group F0: Standard Parameters				
F0-00	G/P type display	1: G type (constant torque load)	1	●
F0-01	Motor 1 control mode	0: Sensorless vector control (SVC) 1: Reserved 2: V/F control	0	★
F0-02	Command source selection	0: External LCD panel/Commissioning software 1: Terminal I/O control 2: Communication control	0	★
F0-03	Main frequency reference X selection	0: Digital setting (initial value F0-08 can be modified by keypad or terminal UP/DOWN, non-retentive at power failure) 1: Digital setting (initial value F0-08 can be modified by keypad or terminal UP/Down, retentive at power failure) 2: AI1 3: AI2 4: (Reserved) 5: Pulse setting (DIO1) 6: Multi-reference 7: Simple PLC 8: PID 9: Communication setting 10: Synchronization control 11: Air compressor control	11	★

Param. No.	Param. Name	Setting Range	Default	Property
F0-04	Auxiliary frequency reference Y selection	0: Digital setting (initial value F0-08 can be modified by keypad or terminal UP/DOWN, non-retentive at power failure) 1: Digital setting (initial value F0-08 can be modified by keypad or terminal UP/Down, retentive at power failure) 2: AI1 3: AI2 4: (Reserved) 5: Pulse setting (DIO1) 6: Multi-reference 7: Simple PLC 8: PID 9: Communication setting 10: Synchronization control	0	★
F0-05	Base value of range of auxiliary frequency reference Y for main and auxiliary calculation	0: Relative to the maximum frequency 1: Relative to main frequency X	0	☆
F0-06	Range of auxiliary frequency source Y for main and auxiliary calculation	0% to 150%	100%	☆
F0-07	Final frequency reference setting selection	Ones (Frequency source selection) 0: Main frequency reference X 1: Main and auxiliary calculation result (based on the tens position) 2: Switchover between main frequency reference X and auxiliary frequency reference Y 3: Switchover between main frequency reference X and main and auxiliary calculation result 4: Switchover between auxiliary frequency reference Y and main and auxiliary calculation result Tens (X and Y superposition relationship) 0: Main + Auxiliary 1: Main - Auxiliary 2: Max. (main, auxiliary) 3: Min. (main, auxiliary) 4: Main x Auxiliary	0	☆
F0-08	Preset frequency	0.00 Hz to F0-10 (Maximum frequency)	50.00 Hz	☆
F0-09	Running direction	0: Run in the same direction 1: Run in the reverse direction	0	☆
F0-10	Maximum frequency	5.00 Hz to 600.00 Hz	155.00 Hz	★

Appendix A Parameter Table

Param. No.	Param. Name	Setting Range	Default	Property
F0-11	Setting channel of frequency reference upper limit	0: Set by F0-12 1: AI1 2: AI2 4: Pulse reference (DIO1) 5: Communication setting 6: Multi-reference	0	★
F0-12	Frequency reference upper limit	F0-14 (Frequency reference lower limit) to F0-10 (Maximum frequency)	155.00 Hz	☆
F0-13	Frequency reference upper limit offset	0.00 Hz to F0-10 (Maximum frequency)	0.00 Hz	☆
F0-14	Frequency reference lower limit	0.00 Hz to F0-12 (Frequency reference upper limit)	0.00 Hz	☆
F0-15	Carrier frequency	2.0 kHz to 8.0 kHz	4.0 kHz	☆
F0-16	Carrier frequency adjusted with load	0: Disabled 1: Enabled	1	☆
F0-17	Acceleration time 1	0.00s to 6500.0s	20.0s	☆
F0-18	Deceleration time 1	0.00s to 6500.0s	20.0s	☆
F0-19	Acceleration/Deceleration time unit	0: 1s 1: 0.1s 2: 0.01s	1	★
F0-21	Frequency offset of auxiliary frequency setting channel for main and auxiliary calculation	0.00 Hz to F0-10 (Maximum frequency)	0.00 Hz	☆
F0-22	Frequency reference resolution	1: 0.1 Hz 2: 0.01 Hz	2	★
F0-23	Retentive of digital setting frequency upon stop	0: Disabled 1: Enabled	0	☆
F0-25	Acceleration/Deceleration time base frequency	0: Maximum frequency (F0-10) 1: Frequency reference 2: 100 Hz	0	★
F0-26	Base frequency for UP/DOWN modification during running	0: Running frequency 1: Frequency reference	0	★
F0-27	Main frequency reference coefficient	0.00% to 100.00%	10.00%	☆
F0-28	Auxiliary frequency coefficient	0.00% to 100.00%	10.00%	☆
Group F1: Motor 1 Parameters				
F1-00	Motor type selection	0: Common asynchronous motor 1: Variable frequency asynchronous motor 2: Synchronous motor	2	★
F1-01	Rated motor power	0.1 kW to 1000.0 kW	Model dependent	★
F1-02	Rated motor voltage	1 V to 2000 V	Model dependent	★

Param. No.	Param. Name	Setting Range	Default	Property
F1-03	Rated motor current	0.01 A to 655.35 A (AC drive power \leq 55 kW) 0.1 A to 6553.5 A (AC drive power > 55 kW)	Model dependent	★
F1-04	Rated motor frequency	0.01 Hz to F0-10 (Maximum frequency)	Model dependent	★
F1-05	Rated motor rotation speed	1 rpm to 65535 rpm	Model dependent	★
F1-06	Asynchronous/ Synchronous motor stator resistance	0.001 Ω to 65.535 Ω (AC drive power \leq 55 kW) 0.0001 Ω to 6.5535 Ω (AC drive power > 55 kW)	Auto-tuning parameter	★
F1-07	Asynchronous motor rotor resistance	0.001 Ω to 65.535 Ω (AC drive power \leq 55 kW) 0.0001 Ω to 6.5535 Ω (AC drive power > 55 kW)	Auto-tuning parameter	★
F1-08	Asynchronous motor leakage inductive reactance	0.01 mH to 655.35 mH (AC drive power \leq 55 kW) 0.001 mH to 65.535 mH (AC drive power > 55 kW)	Auto-tuning parameter	★
F1-09	Asynchronous motor mutual inductive reactance	0.1 mH to 6553.5mH (AC drive power \leq 55 kW) 0.01 mH to 655.35 mH (AC drive power > 55 kW)	Auto-tuning parameter	★
F1-10	Asynchronous motor no-load current	0.01 A to F1-03 (AC drive power \leq 55 kW) 0.1 A to F1-03 (AC drive power > 55 kW)	Auto-tuning parameter	★
F1-11	Asynchronous motor iron-core saturation coefficient 1	50.0% to 100.0%	86.0%	☆
F1-12	Asynchronous motor iron-core saturation coefficient 2	100.0% to 150.0%	130.0%	☆
F1-13	Asynchronous motor iron-core saturation coefficient 3	100.0% to 170.0%	140.0%	☆
F1-14	Asynchronous motor iron-core saturation coefficient 4	100.0% to 180.0%	150.0%	☆
F1-17	Synchronous motor axis D inductance	0.01 mH to 655.35 mH (AC drive power \leq 55 kW) 0.001 mH to 65.535 mH (AC drive power > 55 kW)	Auto-tuning parameter	★
F1-18	Synchronous motor axis D inductance	0.01 mH to 655.35 mH (AC drive power \leq 55 kW) 0.001 mH to 65.535 mH (AC drive power > 55 kW)	Auto-tuning parameter	★
F1-19	Synchronous motor back EMF	0.1V to 6553.5V	Auto-tuning parameter	★

Appendix A Parameter Table

Param. No.	Param. Name	Setting Range	Default	Property
F1-23	Percentage of friction torque	0.00% to 100.00%	0.00%	★
F1-26	Auto-tuning direction (inertia and synchronous motor auto-tuning)	0 to 1	1	★
F1-32	Numerator of motor gear ratio	1 to 65535	1	★
F1-33	Denominator of motor gear ratio	1 to 65535	1	★
F1-37	Auto-tuning selection	0: No operation 1: Asynchronous motor static auto-tuning 2: Asynchronous motor no-load complete auto-tuning 3: Asynchronous motor with-load complete auto-tuning 4: Reserved 11: Synchronous motor no-load partial auto-tuning (back EMF exclusive) 12: Synchronous motor dynamic no-load auto-tuning 13: Synchronous motor static complete auto-tuning 14: Reserved	0	★
Group F2: Motor 1 Vector Control Parameters				
F2-00	Speed loop proportional gain Kp at low speed	1 to 200	30	☆
F2-01	Speed loop integral time Ti at low speed	0.001s to 10.000s	0.500s	☆
F2-02	Switchover frequency 1	0.00 to F2-05 (Switchover frequency 2)	5.00 Hz	☆
F2-03	Speed loop proportional gain Kp at high speed	1 to 200	20	☆
F2-04	Speed loop integral time Ti at high speed	0.001s to 10.000s	1.000s	☆
F2-05	Switchover frequency 2	F2-02 (Switchover frequency 1) to the maximum frequency	10.00 Hz	☆
F2-06	SVC/FVC slip compensation gain	50% to 200%	100%	☆
F2-07	Speed feedback filter time	0.000s to 0.100s	0.004s	☆
F2-08	VC deceleration over-excitation gain	0 to 200	64	☆

Param. No.	Param. Name	Setting Range	Default	Property
F2-09	Torque upper limit source in speed control (electric)	0: Digital setting (F2-10) 1: AI1 2: AI2 4: Pulse reference (DIO1) 5: Communication setting (1000H) 6: Min. (AI1, AI2) 7: Max. (AI1, AI2) 100% of the values 1 to 7 corresponding to F2-10	0	☆
F2-10	Torque upper limit setting in speed control (electric)	0.0% to 200.0%	150.0%	☆
F2-11	Torque upper limit source in speed control (generating)	0: Digital setting (F2-10) 1: AI1 2: AI2 4: Pulse reference (DIO1) 5: Communication setting (1000H) 6: Min. (AI1, AI2) 7: Max. (AI1, AI2) 8: Digital setting (F2-12)	0	☆
F2-12	Digital setting of torque limit in speed control (generating)	0.0% to 200.0%	150.0%	☆
F2-13	Current loop proportional gain Kp at low speed	0.1 to 10.0	1.0	☆
F2-14	Current loop integral gain Ki at low speed	0.1 to 10.0	1.0	☆
F2-15	Current loop proportional gain Kp at high speed	0.1 to 10.0	1.0	☆
F2-16	Current loop integral gain Ki at high speed	0.1 to 10.0	1.0	☆
F2-17	Speed loop proportional gain Kp at zero speed lock	1 to 100	30	☆
F2-18	Speed loop integral time Ti at zero speed lock	0.001s to 10.000s	0.500s	☆
F2-20	Speed loop switchover frequency at zero speed lock	0.00 to F2-02 (Switchover frequency 2)	0.05 Hz	☆
F2-21	Maximum output voltage coefficient	100 to 110	100	☆
F2-22	Output voltage filter time	0.000 to 0.010s (Switchover frequency 2)	0.000s	☆
F2-23	Position lock at zero speed	0: Disabled 1: Enabled	0	★

Appendix A Parameter Table

Param. No.	Param. Name	Setting Range	Default	Property
F2-24	Vector overvoltage suppression KP	0 to 1000	40	☆
F2-25	Acceleration rate compensation gain	0 to 200	0:	☆
F2-26	Acceleration rate compensation filter	0 to 500	10	☆
F2-27	Vector overvoltage suppression	0: Disabled 1: Enabled	1	☆
F2-28	Torque reference filter cutoff frequency	50 Hz to 1000 Hz	500 Hz	☆
F2-29	Initial position angle detection current of synchronous motor	50% to 180%	80%	☆
F2-30	Automatic calculation of speed loop parameters	0: Disabled 1: Enabled	0	★
F2-31	Expected speed loop bandwidth (high speed)	1.0 Hz to 200.0 Hz	10.0 Hz	☆
F2-32	Expected speed loop bandwidth (low speed)	1.0 Hz to 200.0 Hz	10.0 Hz	☆
F2-33	Expected speed loop bandwidth (zero speed)	1.0 to 200.0Hz	10.0 Hz	☆
F2-34	Expected speed loop damping ratio	0.100 to 65.000	1.000	☆
F2-35	System inertia	0.001s to 50.000s (equivalent to start-up time)	Model dependent	★
F2-36	Single motor inertia	0.001 kg*m ² to 50.000 kg*m ²	Model dependent	★
F2-43	Inertia auto-tuning and dynamic speed reference	0% to 100% (base value: rated motor frequency)	30%	★
F2-47	Inertia auto-tuning	0: Disabled 1: Enabled	0	★
F2-48	Speed loop bandwidth setting value in inertia auto-tuning	0.1 Hz to 100.0 Hz	10.0 Hz	★
F2-50	Inertia auto-tuning mode	0: Acceleration/Deceleration mode 1: Triangular wave mode	0	★
F2-51	Inertia auto-tuning acceleration/deceleration coefficient	0.1 to 10.0	1.0	★
F2-52	Decoupling control	0 to 1	0	★
F2-53	Generating power limit selection	0: Disabled 1: Enabled	0	★

Param. No.	Param. Name	Setting Range	Default	Property
F2-54	Generating power limit	0.0% to 200.0%	0.0%	★
Group F3: V/F Control Parameters				
F3-00	V/F curve setting	0: Linear V/F 1: Multi-point V/F 2: Square V/F 3: 1.2-power V/F 4: 1.4-power V/F 6: 1.6-power V/F 8: 1.8-power V/F 10: V/F complete separation 11: V/F half separation	0	★
F3-01	Torque boost	0.0%: Automatic torque boost 0.1% to 30.0%	Model dependent	☆
F3-02	Cut-off frequency of torque boost	0.00 Hz to the maximum frequency	50.00 Hz	★
F3-03	Multi-point V/F frequency 1	0.00 Hz to F3-05 (Multi-point V/F frequency 2)	0.00 Hz	★
F3-04	Multi-point V/F voltage 1	0.0% to 100.0%	0.0%	★
F3-05	Multi-point V/F frequency 2	F3-03 (Multi-point V/F frequency 1) to F3-07 (Multi-point V/F frequency 3)	0.00 Hz	★
F3-06	Multi-point V/F voltage 2	0.0% to 100.0%	0.0%	★
F3-07	Multi-point V/F frequency 3	F3-05 to F1-04 (Rated motor frequency)	0.00 Hz	★
F3-08	Multi-point V/F voltage 3	0.0% to 100.0%	0.0%	★
F3-09	V/F slip compensation gain	0.0% to 200.0%	0.0%	☆
F3-10	V/F over-excitation gain	0 to 200	64	☆
F3-11	V/F oscillation suppression gain	0 to 100	Model dependent	☆
F3-12	Oscillation suppression gain function	0: Disabled 3: Enabled	3	★
F3-13	Voltage source for V/F separation	0: Set by F3-14 1: AI1 2: AI2 4: Pulse setting (DIO1) 5: Multi-reference 6: Simple PLC 7: PID 8: Communication setting	0	☆
F3-14	Digital setting of voltage for V/F separation	0 V to the rated motor voltage	0 V	☆

Appendix A Parameter Table

Param. No.	Param. Name	Setting Range	Default	Property
F3-15	Voltage rise time of V/F separation	0.0s to 1000.0s Note: It sets the time for the output voltage to rise from 0 to the rated motor voltage.	0.0s	☆
F3-16	Voltage decline time of V/F separation	0.0s to 1000.0s Note: It sets the time for the output voltage to rise from 0 to the rated motor voltage.	0.0s	☆
F3-17	Stop mode selection for V/F separation	0: Frequency and voltage declining to 0 independently 1: Frequency declining after voltage declines to 0	0	★
F3-18	V/F current limit level	50% to 200%	150%	★
F3-19	V/F current limit selection	0: Disabled 1: Enabled	1	★
F3-20	V/F current limit gain	0 to 100	20	☆
F3-21	V/F compensation factor of speed multiplying current limit level	50 to 200	50	★
F3-22	V/F voltage limit	650.0 V to 800.0 V	770.0 V	★
F3-23	V/F voltage limit selection	0: Disabled 1: Enabled	1	★
F3-24	V/F frequency gain for voltage limit	0 to 100	30	☆
F3-25	V/F voltage gain for voltage limit	0 to 100	30	☆
F3-26	V/F frequency rise threshold during voltage limit	0 to 50	5	★
F3-27	Slip compensation time constant	0.1 to 10.0	0.5	☆
F3-28	Automatic frequency rise	0: Disabled 1: Enabled	0	★
F3-29	Minimum motoring torque current	10 to 100	50	★
F3-30	Maximum generating torque current	10 to 100	20	★
F3-31	Automatic frequency rise KP	0 to 100	50	☆
F3-32	Automatic frequency rise KI	0 to 100	50	☆
F3-33	Online torque compensation gain	80 to 150	100	★
Group F4: Input Terminals				

Param. No.	Param. Name	Setting Range		Default	Property
F4-00	DI1 function selection	0: No function	32: Immediate DC injection braking	33	★
F4-01	DI2 function selection	1: Forward run (FWD)	33: External fault normally closed (NC) input		
F4-02	DI3 function selection	2: Reverse run (REV)	34: Frequency modification enabled	1	★
F4-03	DI4 function selection	3: Three-wire control	35: Reverse PID operation direction		
F4-04	DI5 function selection	4: Forward jog (FJOG)	36: External stop terminal 1	0:	★
F4-05	DI6 function selection	5: Reverse jog (RJOG)	37: Command source switchover terminal 2		
F4-06	DI7 function selection	6: Terminal UP	38: PID integral disabled	0:	★
F4-07	DI8 function selection	7: Terminal DOWN	39: Switchover between main frequency source X and preset frequency		
F4-08	DI9 function selection	8: Coast to stop	40: Switchover between auxiliary frequency source Y and preset frequency	13	★
F4-09	DI10 function selection	9: Fault reset (RESET)	41: Reserved		
F4-10	DI11 function selection	10: Running pause	42: Position lock enabled	0	★
F4-11	DI12 function selection	11: External fault normally open (NO) input	43: PID parameter switchover		
F4-12	DI13 function selection	12: Multi-reference terminal 1	44: User-defined fault 1	0	★
F4-13	DI14 function selection	13: Multi-reference terminal 2	45: User-defined fault 2		
F4-14	DI15 function selection	14: Multi-reference terminal 3	46: Speed control/Torque control switchover	0	★
F4-15	DI16 function selection	15: Multi-reference terminal 4	47: Emergency stop		
F4-16	DI17 function selection	16: Terminal 1 for acceleration/deceleration time selection	48: External stop terminal 2	0	★
F4-17	DI18 function selection	17: Terminal 2 for acceleration/deceleration time selection	49: Deceleration DC injection braking		
F4-18	DI19 function selection	18: Frequency source switchover	50: Clear the current running time	0	★
F4-19	DI20 function selection	19: UP and DOWN setting clear (terminal, operation panel)	51: Two-wire/Three-wire control switchover		
F4-20	DI21 function selection	20: Running command switchover terminal	52: Startup protection terminal	0	★
F4-21	DI22 function selection	21: Acceleration/Deceleration prohibited	53: Oil fine separator blocked		
F4-22	DI23 function selection	22: PID pause	54: Oil separator blocked	0	★
F4-23	DI24 function selection	23: PLC status reset	55: Oil filter blocked		
F4-24	DI25 function selection	24: Wobble pause	56: Air filter blocked	0	★
F4-25	DI26 function selection	25: Counter input (DIO1)	59: Low pressure difference of water pump		
F4-26	DI27 function selection	26: Counter reset	60: Remote start/stop	0	★
F4-27	DI28 function selection	27: Length count input (DIO1)	61 to 63: Reserved		
F4-28	DI29 function selection	28: Length reset		0	★
F4-29	DI30 function selection	29: Torque control inhibited			
F4-30	DI31 function selection	30: Reserved		0.010s	☆
F4-31	DI32 function selection	31: Reserved			
F4-10	DI filter time	0.000s to 1.000s		0.010s	☆

Appendix A Parameter Table

Param. No.	Param. Name	Setting Range	Default	Property
F4-11	Terminal I/O control mode	0: Two-wire control mode 1 1: Two-wire control mode 2 2: Three-wire control mode 1 3: Three-wire control mode 2	0	★
F4-12	Terminal UP/DOWN rate	0.001 Hz/s to 65.535 Hz/s	1.000 Hz/s	☆
F4-13	AI curve 1 minimum input	-10.00 V to F4-15 (AI curve 1 maximum input)	-10.00 V	☆
F4-14	Corresponding percentage of AI curve 1 minimum input	-100.0% to +100.0%	-100.0%	☆
F4-15	AI curve 1 maximum input	F4-13 (AI curve 1 minimum input) to +10.00 V	10.00 V	☆
F4-16	Corresponding percentage of AI curve 1 maximum input	-100.0% to +100.0%	100.0%	☆
F4-17	AI1 filter time	0.00s to 10.00s	0.10s	☆
F4-18	AI curve 2 minimum input	0.00 V to F4-20 (AI curve 2 maximum input)	0.00 V	☆
F4-19	Corresponding percentage of AI curve 2 minimum input	-100.0% to +100.0%	0.0%	☆
F4-20	AI curve 2 maximum input	F4-18 (AI curve 2 minimum input) to +10.00 V	10.00 V	☆
F4-21	Corresponding percentage of AI curve 2 maximum input	-100.0% to +100.0%	100.0%	☆
F4-22	AI2 filter time	0.00s to 10.00s	0.10s	☆
F4-23	AI curve 3 minimum input	0.00 V to F4-25 (AI curve 3 maximum input)	0.00 V	☆
F4-24	Corresponding percentage of AI curve 3 minimum input	-100.0% to +100.0%	0.0%	☆
F4-25	AI curve 3 maximum input	F4-23 (AI curve 3 minimum input) to +10.00 V	10.00 V	☆
F4-26	Corresponding percentage of AI curve 3 maximum input	-100.0% to +100.0%	100.0%	☆
F4-28	Pulse minimum input	0.00 kHz to F4-30 (Pulse maximum input)	0.00 kHz	☆
F4-29	Corresponding percentage of pulse minimum input	-100.0% to 100.0%	0.0%	☆
F4-30	Pulse maximum input	F4-28 (Pulse minimum input) to 100.00 kHz	50.00 kHz	☆
F4-31	Corresponding setting of pulse maximum input	-100.0% to 100.0%	100.0%	☆
F4-32	Pulse filter time	0.00s to 10.00s	0.10s	☆

Param. No.	Param. Name	Setting Range	Default	Property
F4-33	AI curve selection	Ones: AI1 curve selection 1: Curve 1 (2 points, see F4-13 to F4-16) 2: Curve 2 (2 points, see F4-18 to F4-21) 3: Curve 3 (2 points, see F4-23 to F4-26) 4: Curve 4 (4 points, see A6-00 to A6-07) 5: Curve 5 (4 points, see A6-08 to A6-15) Tens: AI2 curve selection, same as AI1 Hundreds: Reserved	321	☆
F4-34	Setting for AI less than minimum input	Ones: Setting for AI1 less than minimum input 0: Corresponding percentage of minimum input 1: 0.0% Tens: Setting for AI2 less than minimum input, same as AI1 Hundreds: Reserved	0	☆
F4-35	DI1 delay	0.0s to 3600.0s	0.0s	☆
F4-36	DI2 delay	0.0s to 3600.0s	0.0s	☆
F4-37	DI3 delay	0.0s to 3600.0s	0.0s	☆
F4-38	DI active mode selection 1	0: High level active 1: Low level active Ones: DI1 Tens: DI2 Hundreds: DI3 Thousands: DI4 Ten thousands: DI5	0:	★
F4-39	DI active mode selection 2	0: High level active 1: Low level active Ones: DI1 Tens: DI2 Hundreds: DI3 Thousands: DI4 Ten thousands: DI5	0:	★
F4-40	AI input type	0: Voltage input 1: Current input (input impedance 500 Ω) 1: Current input (input impedance 250 Ω)	0	★
F4-41	DIO terminal type	Ones: DIO1 type 0: DI/Pulse 1: DO Tens: DIO2 type 0: DI 1: DO/FMP	00	★
Group F5: Output Terminals				
F5-00	DIO2 terminal output mode	0: Pulse output (FMP) 1: Switch output (FMR)	0	☆

Appendix A Parameter Table

Param. No.	Param. Name	Setting Range		Default	Property	
F5-01	FMR output function selection	0: No function 1: AC drive running 2: Fault output (stop upon fault) 3: Frequency-level detection output 4: Frequency reached 5: Zero-speed running (no output at stop) 6: Motor overload pre-warning 7: AC drive overload pre-warning 8: Set count value reached 9: Designated count value reached 10: Length reached 11: PLC cycle completed 12: Accumulative running time reached 13: Frequency limited 14: Torque limited 15: Ready for run 16: AI1 > AI2 17: Frequency upper limit reached 18: Frequency lower limit reached (related to running) 19: Undervoltage state output	20: Communication setting 23: Zero-speed running 2 (having output at stop) 24: Accumulative power-on time reached 25: Frequency-level detection 2 output 26: Frequency 1 reached output 27: Frequency 2 reached output 28: Current 1 reached output 29: Current 2 reached output 30: Timing reached output 31: AI1 input limit exceeded 32: AC drive output load loss 33: Reverse running 34: Zero current state 35: IGBT temperature reached 36: Output current limit exceeded 37: Frequency lower limit reached (having output at stop) 38: Abnormality output (direct output at fault or warning) 39: Motor overheat pre-warning 40: Current running time reached 41: Fault output 2 42: Fault output 3 43: Position lock enabled	0	☆	
F5-02	Relay function selection				2	☆
F5-03	Second solenoid valve action selection (T2A-T2C)				1	
F5-04	DO1 function selection				0	☆

Param. No.	Param. Name	Setting Range	Default	Property
F5-06	FMP output function selection	0: Output frequency 1: Set frequency 2: Output current 3: Output torque (100.0% corresponding to two times of the rated motor torque) 4: Output power 5: Output voltage (100% corresponding to 1.2 times of the rated AC drive voltage) 6: Pulse reference (100% corresponding to 50.0 kHz)	0	☆
F5-07	AO1 function selection	7: AI1 8: AI2 9: Reserved 10: Length 11: Count value 12: Communication setting 13: Motor speed 14: Output current (100.0% corresponding to 1000.0 A) 15: Output voltage (100.0% corresponding to 1000.0 V) 16: Output torque (directional, 100.0% corresponding to two times of the rated motor torque) 19: Taper output	0	☆
F5-09	Maximum FMP output frequency	0.01 kHz to 100.00 kHz	50.00 kHz	☆
F5-10	AO1 zero offset coefficient	-100.0% to +100.0%	0.0%	☆
F5-11	AO1 gain	-10.00 to +10.00	1.00	☆
F5-17	FMR output delay	0.0s to 3600.0s	0.0s	☆
F5-18	Relay 1 output delay	0s to 65535s	0s	☆
F5-19	Relay 2 output delay	0s to 65535s	0s	☆
F5-20	DIO1 output delay	0.0s to 3600.0s	0.0s	☆
F5-22	DO active mode selection	0: Positive logic active 1: Negative logic active Ones: FMR (DIO2) Tens: RELAY1 Hundreds: Reserved Thousands: DIO1 Ten thousands: Reserved	0	☆
F5-23	AO1 mode selection	0: Voltage output 1: Current output	0	★

Appendix A Parameter Table

Param. No.	Param. Name	Setting Range	Default	Property
Group F6: Start/Stop Control				
F6-00	Start mode	0: Direct start 1: Catching a spinning motor (asynchronous motor) 2: Pre-excitation startup (asynchronous motor)	0	☆
F6-01	Mode of catching a spinning motor	0: From stop frequency 1: From 50 Hz 2: From the maximum frequency	0	★
F6-02	Speed of catching a spinning motor	1 to 100	20	☆
F6-03	Startup frequency	0.00 Hz to 10.00 Hz	0.00 Hz	☆
F6-04	Startup frequency active time	0.0s to 100.0s	0.0s	★
F6-05	Startup DC injection braking current/ pre-excitation current	0% to 100%	0%	★
F6-06	Startup DC injection braking active time/ pre-excitation active time	0.0s to 100.0s	0.0s	★
F6-07	Acceleration/Deceleration mode	0: Linear acceleration/deceleration 1: S-curve acceleration/deceleration	0	★
F6-08	Time proportion of S-curve start segment	0.0% to (100% - F6-09)	30.0%	★
F6-09	Time proportion of S-curve end segment	0.0% to (100% - F6-09)	30.0%	★
F6-10	Stop mode	0: Decelerate to stop 1: Coast to stop	0	☆
F6-11	Shutdown DC injection braking/Position lock start frequency	0.00 Hz to the maximum frequency	0.00 Hz	☆
F6-12	Shutdown DC injection braking delay	0.0s to 100.0s	0.0s	☆
F6-13	Shutdown DC injection braking current	0% to 100%	0%	☆
F6-14	Shutdown DC injection braking active time	0.0s to 100.0s	0.0s	☆
F6-15	Braking use ratio	0% to 100%	100%	★
F6-16	Closed-loop current KP of catching a spinning motor	0 to 1000	500	☆
F6-17	Closed-loop current Ki of catching a spinning motor	0 to 1000	800	☆
F6-18	Current of catching a spinning motor	30 to 200	100	☆

Param. No.	Param. Name	Setting Range	Default	Property
F6-20	Voltage rise time at catching a spinning motor	0.5s to 3.0s	1.0s	☆
F6-21	Demagnetization time	00.00s to 10.00s	1.00s	☆
F6-22	Startup pre-torque setting	000.0% to 200.0%	0.0%	☆
F6-23	Operation at command from power supply unit	0: Stop according to F6-10 1: Ignore stop command	0	★
F6-24	Position lock KP	0.0 to 100.0	10.0	☆
F6-25	Position lock end amplitude	0 to 16383	10	☆
Group F7: Keypad Operation and LED Display				
F7-03	LED display running parameter 1	0000 to FFFF Bit00: Running frequency (Hz) Bit01: Frequency reference (Hz) Bit02: Bus voltage (V) Bit03: Output voltage (V) Bit04: Output current (A) Bit05: Output power (kW) Bit06: Output torque (%) Bit07: DI state Bit08: DO state Bit09: AI1 voltage Bit10: AI2 voltage (V) Bit11: Reserved Bit12: Count value Bit13: Length value Bit14: Load speed display Bit15: PID reference	1F	☆
F7-04	LED display running parameter 2	0000 to FFFF Bit00: PID feedback Bit01: PLC stage Bit02: Pulse input frequency (kHz) Bit03: Running frequency 2 (Hz) Bit04: Remaining running time Bit05: AI1 voltage before correction (V) Bit06: AI2 voltage before correction (V) Bit07: Reserved Bit08: Linear speed Bit09: Current power-on time (h) Bit10: Current running time (min) Bit11: Pulse input frequency (Hz) Bit12: Communication setting value Bit13: Reserved Bit14: Main frequency X display (Hz) Bit15: Auxiliary frequency Y display (Hz)	0	☆

Appendix A Parameter Table

Param. No.	Param. Name	Setting Range	Default	Property
F7-05	LED display stop parameters	0000 to FFFF Bit00: Frequency reference (Hz) Bit01: Bus voltage (V) Bit02: DI state Bit03: DO state Bit4: AI1 voltage (V) Bit05: AI2 voltage (V) Bit06: Reserved Bit07: Count value Bit08: Length value Bit09: PLC stage Bit10: Load speed Bit11: PID setting Bit12: Pulse input frequency (kHz)	33	☆
F7-06	Load speed display coefficient	0.0001 to 6.5000	1	☆
F7-07	Heatsink temperature of IGBT	0.0°C to 100.0°C	-	●
F7-08	Product No.	810	-	●
F7-09	Accumulative running time	0h to 65535h	-	●
F7-10	Performance software version	-	-	●
F7-11	Function software version	-	-	●
F7-12	Number of decimal places for load speed display	0: 0 decimal place 1: 1 decimal place 2: 2 decimal places 3: 3 decimal places	1	☆
F7-13	Accumulative power-on time	0h to 65535h	-	●
F7-14	Accumulative power consumption	0 kWh to 65535 kWh	-	●
Group F8: Auxiliary Functions				
F8-00	Jog running frequency	0.00 Hz to the maximum frequency	2.00 Hz	☆
F8-01	Jog acceleration time	0.0s to 6500.0s	20.0s	☆
F8-02	Jog deceleration time	0.0s to 6500.0s	20.0s	☆
F8-03	Acceleration time 2	0.0s to 6500.0s	Model dependent	☆
F8-04	Deceleration time 2	0.0s to 6500.0s	Model dependent	☆
F8-05	Acceleration time 3	0.0s to 6500.0s	Model dependent	☆
F8-06	Deceleration time 3	0.0s to 6500.0s	Model dependent	☆
F8-07	Acceleration time 4	0.0s to 6500.0s	Model dependent	☆

Param. No.	Param. Name	Setting Range	Default	Property
F8-08	Deceleration time 4	0.0s to 6500.0s	Model dependent	☆
F8-09	Jump frequency 1	0.00 Hz to the maximum frequency	0.00Hz	☆
F8-10	Jump frequency 2	0.00 Hz to the maximum frequency	0.00Hz	☆
F8-11	Jump frequency band	0.00 Hz to the maximum frequency	0.00Hz	☆
F8-12	Forward/Reverse run switchover dead-zone time	0.0s to 3000.0s	0.0s	☆
F8-13	Reverse run control	0: Enabled 1: Disabled	0	☆
F8-14	Running mode when frequency reference lower than frequency lower limit	0: Run at frequency lower limit 1: Stop 2: Run at zero speed	0	☆
F8-16	Accumulative power-on time threshold	0h to 65000h	0h	☆
F8-17	Accumulative running time threshold	0h to 65000h	0h	☆
F8-18	Startup protection	0: Disabled 1: Enabled	0	☆
F8-19	Frequency detection value (FDT1)	0.00 Hz to the maximum frequency	50.00Hz	☆
F8-20	Frequency detection hysteresis (FDT1)	0.0% to 100.0% (FDT1 level)	5.0%	☆
F8-21	Detection width of target frequency reached	0.0% to 100.0% (maximum frequency)	0.0%	☆
F8-22	Jump frequency during acceleration/ deceleration	0: Disabled 1: Enabled	0:	☆
F8-25	Switchover frequency of acceleration time 1 and acceleration time 2	0.00 Hz to the maximum frequency	0.00 Hz	☆
F8-26	Switchover frequency of deceleration time 1 and deceleration time 2	0.00 Hz to the maximum frequency	0.00 Hz	☆
F8-27	Set highest priority to jog function	0: Disabled 1: Enabled	0:	☆
F8-28	Frequency detection value (FDT2)	0.00 Hz to the maximum frequency	50.00 Hz	☆
F8-29	Frequency detection hysteresis (FDT2)	0.0% to 100.0% (FDT2 level)	5.0%	☆
F8-30	Detection of frequency 1	0.00 Hz to the maximum frequency	50.00 Hz	☆
F8-31	Detection width of frequency 1	0.0% to 100.0% (maximum frequency)	0.0%	☆
F8-32	Detection of frequency 2	0.00 Hz to the maximum frequency	50.00 Hz	☆

Appendix A Parameter Table

Param. No.	Param. Name	Setting Range	Default	Property
F8-33	Detection width of frequency 2	0.0% to 100.0% (maximum frequency)	0.0%	☆
F8-34	Zero current detection level	0.0% to 300.0% The value 100.0% corresponds to the rated motor current.	5.0%	☆
F8-35	Zero current detection delay	0.01s to 600.00s	0.10s	☆
F8-36	Output overcurrent threshold	0.0% (no detection) 0.1% to 300.0% (rated motor current)	200.0%	☆
F8-37	Output overcurrent detection delay	0.00s to 600.00s	0.00s	☆
F8-38	Detection level of current 1	0.0% to 300.0% (rated motor current)	100.0%	☆
F8-39	Detection width of current 1	0.0% to 300.0% (rated motor current)	0.0%	☆
F8-40	Detection level of current 2	0.0% to 300.0% (rated motor current)	100.0%	☆
F8-41	Detection width of current 2	0.0% to 300.0% (rated motor current)	0.0%	☆
F8-42	Timing function	0: Disabled 1: Enabled	0:	★
F8-43	Timing duration source	0: Set by F8-44 1: AI1 2: AI2 AI range dependent on F8-44	0	★
F8-44	Timing duration	0.0 min to 6500.0 min	0.0 min	★
F8-45	AI1 input voltage lower limit	0.00 V to F8-46 (AI1 input voltage upper limit)	3.10 V	☆
F8-46	AI1 input voltage upper limit	F8-45 (AI1 input voltage lower limit) to 11.00 V	6.80 V	☆
F8-47	IGBT temperature threshold	0°C to 100°C	75°C	☆
F8-48	Cooling fan working mode	0: Working during drive running 1: Working continuously	0	☆
F8-49	Wakeup frequency	F8-51 (Hibernating frequency) to F0-10 (Maximum frequency)	0.00 Hz	☆
F8-50	Wakeup delay	0.0s to 6500.0s	0.0s	☆
F8-51	Hibernating frequency	0.00 Hz to F8-49 (Wakeup frequency)	0.00 Hz	☆
F8-52	Hibernating delay	0.0s to 6500.0s	0.0s	☆
F8-53	Current running time reached	0.0 min to 6500.0 min	0.0 min	☆
F8-54	STO function	0: Disabled 1: Enabled	0	☆
F8-55	Deceleration time for emergency stop	0.0s to 6500.0s	0.0	☆
F8-56	Jog by LED panel	0	0:	☆

Param. No.	Param. Name	Setting Range	Default	Property
Group F9: Fault and Protection				
F9-00	AC drive overload suppression	0 to 1	0	☆
F9-01	Motor overload protection gain	0.20 to 10.00	1.00	☆
F9-02	Motor overload pre-warning coefficient	50% to 100%	80%	☆
F9-04	Overvoltage threshold	150.0 V to 820.0 V	820.0 V	☆
F9-06	Output phase loss detection before startup	0: Disabled 1: Enabled	0:	☆
F9-07	Detection of short-circuit to ground	0: No detection 1: Detection before power-on 2: Detection during running 3: Detection before power-on and during running	1	★
F9-09	Auto fault reset times	0 to 20	0	☆
F9-10	DO action during auto fault reset	0: Not act 1: Act	0	☆
F9-11	Auto fault reset interval	0.1s to 100.0s	1.0s	☆

Appendix A Parameter Table

Param. No.	Param. Name	Setting Range		Default	Property
F9-14	1st fault type	0: No fault 1: Hardware fault 2: Overcurrent during acceleration 3: Overcurrent during deceleration 4: Overcurrent during constant speed 5: Overvoltage during acceleration 6: Overvoltage during deceleration 7: Overvoltage during constant speed 9: Undervoltage 10: AC drive overload 11: Motor overload 12: Reserved 13: Phase loss on the output side 14: Heatsink over-heat 15: External fault 16: Communication fault 17 to 18: Reserved	19: Motor auto-tuning abnormal 20: Reserved 21: EEPROM read/write error 22: Motor auto-tuning abnormal 23: Motor short-circuited to ground 24: Inter-phase short circuit 25: Power supply unit fault 26: Accumulative running time reached 27: User-defined fault 1 28: User-defined fault 2 29: Power-on time reached 30: Output load lost 31: PID feedback lost during running 42: Excessive speed deviation 43: Motor overspeed 45: Motor overtemperature 80: Fan fault		●
F9-15	2nd fault type				●
F9-16	3rd (latest) fault type				●
F9-17	Frequency upon 3rd fault	0.00 Hz to 655.35 Hz		0.00 Hz	●
F9-18	Current upon 3rd fault	0.00 A to 655.35 A		0.00 A	●
F9-19	Bus voltage upon 3rd fault	0.0 V to 6553.5 V		0.0 V	●
F9-20	DI state upon 3rd fault	0 to 9999		0	●
F9-21	DO state upon 3rd fault	0 to 9999		0	●
F9-22	AC drive state upon 3rd fault	0 to 65535		0	●
F9-23	Power-on time upon 3rd fault	0s to 65535s		0s	●
F9-24	Running time upon 3rd fault	0.0s to 6553.5s		0.0s	●
F9-25	IGBT temperature upon 3rd fault	0.0 V to 6553.5 V		0.0 V	●

Param. No.	Param. Name	Setting Range	Default	Property
F9-26	3rd fault subcode			●
F9-27	Frequency upon 2nd fault	0.00 Hz to 655.35 Hz	0.00 Hz	●
F9-28	Current upon 2nd fault	0.00 A to 655.35 A	0.00 A	●
F9-29	Bus voltage upon 2nd fault	0.0 V to 6553.5 V	0.0 V	●
F9-30	DI state upon 2nd fault	0 to 9999	0	●
F9-31	DO state upon 2nd fault	0 to 9999	0	●
F9-32	AC drive state upon 2nd fault	0 to 65535	0	●
F9-33	Power-on time upon 2nd fault	0s to 65535s	0s	●
F9-34	Running time upon 2nd fault	0.0s to 6553.5s	0.0s	●
F9-35	IGBT temperature upon 2nd fault	0.0 V to 6553.5 V	0.0 V	●
F9-36	2nd fault subcode			●
F9-37	Frequency upon 1st fault	0.00 Hz to 655.35 Hz	0.00 Hz	●
F9-38	Current upon 1st fault	0.00 A to 655.35 A	0.00 A	●
F9-39	Bus voltage upon 1st fault	0.0 V to 6553.5 V	0.0 V	●
F9-40	DI state upon 1st fault	0 to 9999	0	●
F9-41	DO state upon 1st fault	0 to 9999	0	●
F9-42	AC drive state upon 1st fault	0 to 65535	0	●
F9-43	Power-on time upon 1st fault	0s to 65535s	0s	●
F9-44	Running time upon 1st fault	0.0s to 6553.5s	0.0s	●
F9-45	IGBT temperature upon 1st fault	0.0 V to 6553.5 V	0.0 V	●
F9-46	1st fault subcode			●
F9-47	Fault protection action selection 0	Ones: Overcurrent during acceleration (E02) Tens: Overvoltage during acceleration (E05) Hundreds: Reserved Thousands: undervoltage (E09) Ten thousands: AC drive overload (E10) Note: Output phase loss is valid only in V/F control mode when decelerate to stop or alarm is selected.	22022 0: Coast to stop 1: Decelerate to stop 2: Restart allowed 3: Reserved 4: Alarm 5: Canceled	★

Appendix A Parameter Table

Param. No.	Param. Name	Setting Range	Default	Property
F9-48	Fault protection action selection 1	Ones: Motor overload (E11) Tens: Reserved Hundreds: Output phase loss (E13) Thousands: Heatsink overheat (E14) Ten thousands: External fault (E15) Note: Output phase loss is valid only in V/F control mode when decelerate to stop or alarm is selected.	222 0: Coast to stop 1: Decelerate to stop 2: Restart allowed 3: Reserved 4: Alarm 5: Canceled	★
F9-49	Fault protection action selection 2	Ones: Communication timeout (E16) Tens: External DC soft charge unit fault (E17) (only for models of 90 kW and above) Hundreds: Reserved Thousands: Motor auto-tuning fault (E19) Ten thousands: Reserved	50000 0: Coast to stop 1: Decelerate to stop 2: Restart allowed 3: Reserved 4: Alarm 5: Canceled	★
F9-50	Fault protection action selection 3	Ones: EEPROM read/write error (E21) Tens: Motor auto-tuning abnormal (E22) Hundreds: Motor short-circuited to the ground (E23) Thousands: Inter-phase short-circuit (E24) Ten thousands: Power supply unit fault (E25)	55000 0: Coast to stop 1: Decelerate to stop 2: Restart allowed 3: Reserved 4: Alarm 5: Canceled	★
F9-51	Fault protection action selection 4	Ones: Accumulative running time reached (E26) Tens: User-defined fault 1 (E27) Hundreds: User-defined fault 2 (E28) Thousands: Power-on time reached (E29) Ten thousands: Load lost (E30)	50000 0: Coast to stop 1: Decelerate to stop 2: Reserved 3: Reserved 4: Alarm 5: Canceled	★

Param. No.	Param. Name	Setting Range	Default	Property
F9-52	Fault protection action selection 5	Ones: PID feedback lost during running (E31) Tens: Reserved Hundreds: Reserved Thousands: Excessive speed deviation (E42) Ten thousands: Motor overspeed (E43)	52525 0: Coast to stop 1: Decelerate to stop 2: Restart allowed 3: Reserved 4: Alarm 5: Canceled	★
F9-53	Fault protection action selection 6	Ones: Motor overtemperature (E45) Tens: Reserved Hundreds: Reserved Thousands: Reserved Ten thousands: Reserved	55500 0: Coast to stop 1: Decelerate to stop 2: Reserved 3: Reserved 4: Alarm 5: Canceled	★
F9-54	Frequency selection for continuing to run upon fault	0: Current running frequency 1: Frequency reference 2: Frequency upper limit 3: Frequency lower limit 4: Backup frequency upon abnormality	1	☆
F9-55	Backup frequency upon fault	6.0% to 100.0% The value 100.0% corresponds to F0-10 (Maximum frequency).	100.0%	☆
F9-56	Type of motor temperature sensor	0: No sensor (AI input) 1: PT100 2: PT1000	0:	☆
F9-57	Motor overheat protection threshold	0°C to 200°C	110°C	☆
F9-58	Motor overheat pre-warning threshold	0°C to 200°C	90°C	☆
F9-59	Power dip ride-through function selection	0: Disabled 1: Decelerate 2: Decelerate to stop	0	★
F9-60	Threshold of power dip ride-through function disabled	80 to 100%	85%	☆
F9-61	Judging time of bus voltage recovering from power dip	0.0s to 100.0s	0.5s	☆
F9-62	Threshold of power dip ride-through function enabled	60% to 100.0% (standard bus voltage)	80%	☆

Appendix A Parameter Table

Param. No.	Param. Name	Setting Range	Default	Property
F9-64	Load loss detection level	0.0% to 100.0%	10.0%	☆
F9-65	Load loss detection time	0.0s to 60.0s	1.0s	☆
F9-67	Overspeed detection level	0.0% to 50.0% (maximum frequency) (Overspeed detection is disabled when it is set to 0.0%.)	5.0%	☆
F9-68	Overspeed detection time	0.0s to 60.0s	1.0s	☆
F9-69	Detection level of speed error	0.0% to 50.0% (maximum frequency) (Overspeed detection is disabled when it is set to 0.0%.)	20.0%	☆
F9-70	Detection time of speed error	0.0s to 60.0s	5.0s	☆
F9-71	Power dip ride-through gain	0 to 100	40	☆
F9-72	Power dip ride-through integral	0 to 100	30	☆
F9-73	Deceleration time of power dip ride-through	0.0s to 300.0s	20.0s	☆
Group FA: Process Control PID Function				
FA-00	PID reference setting channel	0: Set by FA-01 1: AI1 2: AI2 4: Pulse setting (DIO1) 5: Communication setting (1000H) 6: Multi-reference	0	☆
FA-01	PID digital setting	0.0% to 100.0%	50.0%	☆
FA-02	PID feedback setting channel	0: AI1 1: AI2 3: AI1-AI2 4: Pulse setting (DIO1) 5: Communication setting (1000H) 6: AI1+ AI2 7: Max. (AI1 , AI2) 8: Min. (AI1 , AI2)	0	☆
FA-03	PID operation direction	0: Forward 1: Reverse	0	☆
FA-04	PID reference and feedback range	0 to 65535	1,000	☆
FA-05	Proportional gain Kp1	0.0 to 1000.0	20.0	☆
FA-06	Integral time Ti1	0.01s to 100.00s	2.00s	☆
FA-07	Differential time Td1	0.000s to 10.000s	0.000s	☆
FA-08	PID output limit in reverse direction	0.00 Hz to the maximum frequency	2.00 Hz	☆
FA-09	PID deviation limit	0.0% to 100.0%	0.0%	☆
FA-10	PID differential limit	0.00% to 100.00%	0.10%	☆

Param. No.	Param. Name	Setting Range	Default	Property
FA-11	PID reference change time	0.00 to 650.00s	0.00s	☆
FA-12	PID feedback filter time	0.00 to 60.00s	0.00s	☆
FA-13	PID deviation gain	0.0% to 100.0%	100.0%	☆
FA-15	Proportional gain Kp2	0.0 to 1000.0	20.0	☆
FA-16	Integral time Ti2	0.01s to 100.00s	2.00s	☆
FA-17	Differential time Td2	0.000s to 10.000s	0.000s	☆
FA-18	PID parameter swi- tchover condition	0: Not switchover 1: Switchover by DI 2: Auto switchover based on deviation 3: Auto switchover based on running fre- quency 6: Auto adjustment based on winding diameter 7: Auto adjustment based on percentage of maximum winding diameter	0	☆
FA-19	PID deviation 1 for auto switchover	0.0% to FA-20	20.0%	☆
FA-20	PID deviation 2 for auto switchover	FA-19 to 100.0%	80.0%	☆
FA-21	PID initial value	0.0% to 100.0%	0.0%	☆
FA-22	PID initial value active time	0.00 to 650.00s	0.00s	☆
FA-23	Maximum positive error of two outputs	0.00% to 100.00%	1.00%	☆
FA-24	Maximum negative error of two outputs	0.00% to 100.00%	1.00%	☆
FA-25	PID integral property	PID integral pause 0: Disabled 1: Enabled	0:	☆
FA-26	Detection level of PID feedback loss	0.0%: No detection 0.1% to 100.0%	0.0%	☆
FA-27	Detection time of PID feedback loss	0.0s to 20.0s	0.0s	☆
Group Fb: Wobble Function, Fixed Length, and Count				
Fb-00	Wobble setting mode	0: Relative to the central frequency 1: Relative to the maximum frequency	0	☆
Fb-01	Wobble amplitude	0.0% to 100.0%	0.0%	☆
Fb-02	Wobble step	0.0% to 50.0%	0.0%	☆
Fb-03	Wobble cycle	0.1s to 3000.0s	10.0s	☆
Fb-04	Triangular wave rising time coefficient	0.1% to 100.0%	50.0%	☆
Fb-05	Set length	0 m to 65535 m	1000 m	☆
Fb-06	Actual length	0 m to 65535 m	0 m	☆
Fb-07	Number of pulses per meter	0.1 to 6553.5	100.0	☆
Fb-08	Set count value	1 to 65535	1000	☆

Appendix A Parameter Table

Param. No.	Param. Name	Setting Range	Default	Property
Fb-09	Designated count value	1 to 65535	1000	☆
Fb-10	Reset mode of revolution counting	0: Edge 1: Level	0	☆
Fb-11	Reset signal of revolution counting	0: Retain 1: Reset	0	☆
Fb-12	Calculation retentive at power failure	0: Disabled 1: Enabled	0	☆
Fb-13	Initial value of revolutions	0 to 65535 (Fb-18 = 0) 0.0 to 6553.5 (Fb-18 = 1)	0	☆
Fb-14	Numerator of drive ratio	1 to 65535	1	☆
Fb-15	Denominator of drive ratio	1 to 65535	1	☆
Fb-16	Actual running revolutions (+ FB-13)	0 to 65535 (Fb-18 = 0) 0.0 to 6553.5 (Fb-18 = 1)	0	●
Fb-17	Running revolutions	0 to 65535 (Fb-18 = 0) 0.0 to 6553.5 (Fb-18 = 1)	0	●
Fb-18	Revolution counting accuracy	0: 1 1: 0.1	0	☆
Fb-19	Revolution counting direction	0: Same direction 1: Reverse direction	0	☆
Group FC: Multi-Reference and Simple PLC Function				
FC-00	Reference 0	-100.0% to 100.0%	0.0%	☆
FC-01	Reference 1	-100.0% to 100.0%	0.0%	☆
FC-02	Reference 2	-100.0% to 100.0%	0.0%	☆
FC-03	Reference 3	-100.0% to 100.0%	0.0%	☆
FC-04	Reference 4	-100.0% to 100.0%	0.0%	☆
FC-05	Reference 5	-100.0% to 100.0%	0.0%	☆
FC-06	Reference 6	-100.0% to 100.0%	0.0%	☆
FC-07	Reference 7	-100.0% to 100.0%	0.0%	☆
FC-08	Reference 8	-100.0% to 100.0%	0.0%	☆
FC-09	Reference 9	-100.0% to 100.0%	0.0%	☆
FC-10	Reference 10	-100.0% to 100.0%	0.0%	☆
FC-11	Reference 11	-100.0% to 100.0%	0.0%	☆
FC-12	Reference 12	-100.0% to 100.0%	0.0%	☆
FC-13	Reference 13	-100.0% to 100.0%	0.0%	☆
FC-14	Reference 14	-100.0% to 100.0%	0.0%	☆
FC-15	Reference 15	-100.0% to 100.0%	0.0%	☆
FC-16	Simple PLC running mode	0: Stop after running for one cycle 1: Keep final values after running for one cycle 2: Repeat after running for one cycle	0	☆

Param. No.	Param. Name	Setting Range	Default	Property
FC-17	Simple PLC retentive selection	Ones: Retentive upon power failure 0: Non-retentive upon power failure 1: Retentive upon power failure Tens: Retentive upon stop 0: Non-retentive upon stop 1: Retentive upon stop	00	☆
FC-18	Running time of simple PLC reference 0	0.0s (h) to 6553.5s (h)	0.0s (h)	☆
FC-19	Acceleration/deceleration time of simple PLC reference 0	0 to 3	0	☆
FC-20	Running time of simple PLC reference 1	0.0s (h) to 6553.5s (h)	0.0S (h)	☆
FC-21	Acceleration/deceleration time of simple PLC reference 1	0 to 3	0:	☆
FC-22	Running time of simple PLC reference 2	0.0s (h) to 6553.5s (h)	0.0s (h)	☆
FC-23	Acceleration/deceleration time of simple PLC reference 2	0 to 3	0	☆
FC-24	Running time of simple PLC reference 3	0.0s (h) to 6553.5s (h)	0.0s (h)	☆
FC-25	Acceleration/deceleration time of simple PLC reference 3	0 to 3	0	☆
FC-26	Running time of simple PLC reference 4	0.0s (h) to 6553.5s (h)	0.0s (h)	☆
FC-27	Acceleration/deceleration time of simple PLC reference 4	0 to 3	0	☆
FC-28	Running time of simple PLC reference 5	0.0s (h) to 6553.5s (h)	0.0s (h)	☆
FC-29	Acceleration/deceleration time of simple PLC reference 5	0 to 3	0	☆
FC-30	Running time of simple PLC reference 6	0.0s (h) to 6553.5s (h)	0.0s (h)	☆
FC-31	Acceleration/deceleration time of simple PLC reference 6	0 to 3	0	☆
FC-32	Running time of simple PLC reference 7	0.0s (h) to 6553.5s (h)	0.0s (h)	☆
FC-33	Acceleration/deceleration time of simple PLC reference 7	0 to 3	0	☆
FC-34	Running time of simple PLC reference 8	0.0s (h) to 6553.5s (h)	0.0s (h)	☆

Appendix A Parameter Table

Param. No.	Param. Name	Setting Range	Default	Property
FC-35	Acceleration/deceleration time of simple PLC reference 8	0 to 3	0	☆
FC-36	Running time of simple PLC reference 9	0.0s (h) to 6553.5s (h)	0.0s (h)	☆
FC-37	Acceleration/deceleration time of simple PLC reference 9	0 to 3	0	☆
FC-38	Running time of simple PLC reference 10	0.0s (h) to 6553.5s (h)	0.0s (h)	☆
FC-39	Acceleration/deceleration time of simple PLC reference 10	0 to 3	0	☆
FC-40	Running time of simple PLC reference 11	0.0s (h) to 6553.5s (h)	0.0s (h)	☆
FC-41	Acceleration/deceleration time of simple PLC reference 11	0 to 3	0	☆
FC-42	Running time of simple PLC reference 12	0.0s (h) to 6553.5s (h)	0.0s (h)	☆
FC-43	Acceleration/deceleration time of simple PLC reference 12	0 to 3	0	☆
FC-44	Running time of simple PLC reference 13	0.0s (h) to 6553.5s (h)	0.0s (h)	☆
FC-45	Acceleration/deceleration time of simple PLC reference 13	0 to 3	0	☆
FC-46	Running time of simple PLC reference 14	0.0s (h) to 6553.5s (h)	0.0s (h)	☆
FC-47	Acceleration/deceleration time of simple PLC reference 14	0 to 3	0	☆
FC-48	Running time of simple PLC reference 15	0.0s (h) to 6553.5s (h)	0.0s (h)	☆
FC-49	Acceleration/deceleration time of simple PLC reference 15	0 to 3	0	☆
FC-50	Time unit of simple PLC running	0: s (second) 1: h (hour)	0	☆
FC-51	Reference 0 source	0: FC-00 (Reference 0) 1: AI1 2: AI2 4: Pulse setting (DIO1) 5: PID 6: Set by F0-08 (Preset frequency), modified by terminal UP/DOWN	0	☆

Param. No.	Param. Name	Setting Range	Default	Property
Group Fd: Communication Parameters				
Fd-00	Modbus baud rate	0: 300 bps 1: 600 bps 2: 1200 bps 3: 2400 bps 4: 4800 bps 5: 9600 bps 6: 19200 bps 7: 38400 bps 8: 57600 bps 9: 115200 bps	7	☆
Fd-01	Modbus data format	0: No check (8-N-2) 1: Even parity check (8-E-1) 2: Odd parity check (8-O-1) 3: 8-N-1	0:	☆
Fd-02	Modbus local address	1 to 247 (0: Broadcast address)	1	☆
Fd-03	Modbus response delay	0 ms to 20 ms	2	☆
Fd-04	Modbus communication timeout	0.1s to 60.0s 0.0: Disabled	0	☆
Fd-06	Auto reset of communication fault	0: Disabled 1: Enabled	1	☆
Fd-07	Communication between power supply and drive units	0: Disabled 1: Enabled	1	★
Fd-09	Communication status	Ones (CANopen) 0: Stop 1: Initialization 2: Pre-operational 8: Operational Tens (CANlink) 0: Stop 1: Initialization 2: Pre-operational 8: Operational Hundreds (Profibus DP) 0: Stop 1: Initialization 8: Operational	0	●
Fd-10	CANopen/CANlink switchover	1: CANopen 2: CANlink	1	★
Fd-11	CANopen 402	0: Disabled 1: Enabled	0	★

Appendix A Parameter Table

Param. No.	Param. Name	Setting Range	Default	Property
Fd-12	CAN baud rate	0: 20 Kbps 1: 50 Kbps 2: 100 Kbps 3: 125 Kbps 4: 250 Kbps 5: 500 Kbps 6: 1 Mbps	5	★
Fd-13	CAN station number	1 to 127 (Valid for CANlink and CANopen)	1	★
Fd-14	Number of CAN frames received within a period	0 to 65535	1	●
Fd-15	Max. value of node reception error counter	0 to 65535	1	●
Fd-16	Maximum value of node sending error counter	0 to 65535	1	●
Fd-17	Bus disconnection times within a period	0 to 65535	1	●
Fd-18	Power supply unit No.	1 to 99	1	★
Fd-20	Profibus-DP communication address	0 to 125 (0: Broadcast address)	0	★
Fd-21	Profibus-DP communication dropping coefficient	0 to 65535	350	☆
Fd-34	CANopen mode	0: Ordinary mode 1: Expert mode	0	★
Fd-35	CANopen disabling time	0 to 65535 (unit: 100 us)	0	★
Fd-36	CANopen event time	0 ms to 65535 ms	0:	★
Fd-93	Reserved DP network bridge address	0 to 65535	0:	☆
Fd-94	Modbus software version	0 to 65535	0	●
Fd-95	CANlink software version	0 to 65535	0	●
Fd-96	CANopen software version	0 to 65535	0	●
Fd-97	DP software version	0 to 65535	0	●
Fd-98	DP network bridge software version	0 to 65535	0	●
Fd-99	Modbus network bridge software version	0 to 65535	0	●

Param. No.	Param. Name	Setting Range	Default	Property
Group FE: User-Defined Parameters				
FE-00	User-defined parameter 0	F0-00 to FP-xx A0-00 to Ax-xx U0-xx to U0-xx	F0-01	☆
FE-01	User-defined parameter 1		F0-02	☆
FE-02	User-defined parameter 2		F0-03	☆
FE-03	User-defined parameter 3		F0-07	☆
FE-04	User-defined parameter 4		F0-08	☆
FE-05	User-defined parameter 5		F0-17	☆
FE-06	User-defined parameter 6		F0-18	☆
FE-07	User-defined parameter 7		F3-00	☆
FE-08	User-defined parameter 8		F3-01	☆
FE-09	User-defined parameter 9		F4-00	☆
FE-10	User-defined parameter 10		F4-01	☆
FE-11	User-defined parameter 11		F4-02	☆
FE-12	User-defined parameter 12		F5-04	☆
FE-13	User-defined parameter 13		F5-07	☆
FE-14	User-defined parameter 14		F6-00	☆
FE-15	User-defined parameter 15		F6-10	☆
FE-16	User-defined parameter 16		F0-00	☆
FE-17	User-defined parameter 17		F0-00	☆
FE-18	User-defined parameter 18		F0-00	☆
FE-19	User-defined parameter 19		F0-00	☆
FE-20	User-defined parameter 20		F0-00	☆

Appendix A Parameter Table

Param. No.	Param. Name	Setting Range	Default	Property
FE-21	User-defined parameter 21	F0-00 to FP-xx A0-00 to Ax-xx U0-xx to U0-xx	F0-00	☆
FE-22	User-defined parameter 22		F0-00	☆
FE-23	User-defined parameter 23		F0-00	☆
FE-24	User-defined parameter 24		F0-00	☆
FE-25	User-defined parameter 25		F0-00	☆
FE-26	User-defined parameter 26		F0-00	☆
FE-27	User-defined parameter 27		F0-00	☆
FE-28	User-defined parameter 28		F0-00	☆
FE-29	User-defined parameter 29		F0-00	☆
FE-30	User-defined parameter 30		F0-00	☆
FE-31	User-defined parameter 31		F0-00	☆
Group FP: Parameter Management				
FP-00	User password	0 to 65535	0:	☆
FP-01	Parameter initialization	0: No operation 01: Restore factory parameters (excluding motor parameters and F0-10) 02: Clear records 04: Back up current user parameters 501: Recover backup user parameters	0	★
FP-02	Parameter display property	Ones: Group U 0: Hidden 1: Displayed Tens: Group A 0: Hidden 1: Displayed	1	☆
FP-03	Selection of individualized parameter display	Ones: User-defined parameter group 0: Hidden 1: Displayed Tens: User-modified parameter group 0: Hidden 1: Displayed	0	☆
FP-04	Selection of parameter modification property	0: Modification allowed 1: Modification prohibited	0	☆
FP-05	Industry macro	0 to 10	0	☆

Param. No.	Param. Name	Setting Range	Default	Property
Group A0: Torque Control and Limit Parameters				
A0-00	Speed/Torque control	0: Speed control 1: Torque control	0	★
A0-01	Torque reference channel selection in torque control	0: Digital setting 1 (A0-03) 1: AI1 2: AI2 4: Pulse setting (DIO1) 5: Communication setting (1000H) 6: Min. (AI1, AI2) 7: Max. (AI1, AI2) (100.0% of the values 1 to 7 corresponding to A0-03)	0	★
A0-03	Torque digital setting	-200.0% to 200.0%	100.0%	☆
A0-04	Torque filter time	0s to 5.000s	0.000s	☆
A0-05	Speed limit digital setting	-120.0% to 120.0%	0.00%	☆
A0-07	Acceleration time (torque)	0.0s to 650.00s	1.00s	☆
A0-08	Deceleration time (torque)	0.0s to 650.00s	1.00s	☆
A0-09	Setting channel of speed limit	0: Set by A0-05 1: Frequency reference	0	☆
A0-10	Speed limit offset	0 to F0-10 (Maximum frequency)	5.00 Hz	☆
A0-11	Effective mode of speed limit offset	0: Bidirectional offset effective 1: Unidirectional offset effective	1	★
A0-12	Frequency acceleration time	0.0s to 6500.0s	1.0s	☆
A0-13	Frequency deceleration time	0.0s to 6500.0s	1.0s	☆
A0-14	Torque mode switchover	0: No switchover 1: Switchover to speed control at stop 2: Target torque at stop being 0	1	★
Group A1: Virtual DI/DO				
A1-00	VDI1 function selection	Refer to the description of F4-00.	0	★
A1-01	VDI2 function selection	Refer to the description of F4-00.	0	★
A1-02	VDI3 function selection	Refer to the description of F4-00.	0	★
A1-03	VDI4 function selection	Refer to the description of F4-00.	0	★
A1-04	VDI5 function selection	Refer to the description of F4-00.	0	★

Appendix A Parameter Table

Param. No.	Param. Name	Setting Range	Default	Property
A1-05	VDI state setting mode	0: Set by A1-06 1: DO state 2: DI state Ones: VDI1 Tens: VDI2 Hundreds: VDI3 Thousands: VDI4 Ten thousands: VDI5	00000	★
A1-06	Selection of VDI active state	0: Disabled 1: Enabled Ones: VDI1 Tens: VDI2 Hundreds: VDI3 Thousands: VDI4 Ten thousands: VDI5	00000	☆
A1-07	Function selection for AI1 used as DI	Refer to the description of F4-00.	0	★
A1-08	Function selection for AI2 used as DI	Refer to the description of F4-00.	0	★
A1-10	Active state selection for AI used as DI	Ones: AI1 0: High level active 1: Low level active Tens: AI2 0: High level active 1: Low level active	00	★
Group A4: Air Compressor PID Control				
A4-00	Air compressor control mode	0 to 65535	0	☆
A4-01	Open-loop control frequency setting	0 to 65535	0	☆
A4-02	Model switchover frequency ratio	20% to 60%	45	☆
A4-03	Control interval	0 to 65535 ms	0	☆
A4-04	Model proportional coefficient	0 to 65535	0	☆
A4-05	Model time constant	0 to 65535	0	☆
A4-06	Motor acceleration/ deceleration and pipeline lag time constant	0 to 65535	0	☆
A4-07	Air tank volume	0 to 65535 L	0	☆
A4-08	Air compressor volume flow	0 to 65535	0	☆
A4-09	Parameter calculation times	0 to 65535	0	☆

Param. No.	Param. Name	Setting Range	Default	Property
A4-10	Time constant (quick)	0 to 65535	0	☆
A4-11	Frequency suppression coefficient (quick)	0 to 65535	0	☆
A4-12	Time constant (intermediate)	0 to 65535	0	☆
A4-13	Frequency suppression coefficient (intermediate)	0 to 65535	0	☆
A4-14	Time constant (slow)	0 to 65535	0	☆
A4-15	Frequency suppression coefficient (slow)	0 to 65535	0	☆
A4-16	Time constant (slowest)	0 to 65535	0	☆
A4-17	Frequency suppression coefficient (slowest)	0 to 65535	0	☆
A4-18	Parameter calculation function	0 to 65535	0	☆
A4-19	Model proportional coefficient without air tank	0 to 65535	0	☆
A4-20	Model time constant without air tank	0 to 65535	0	☆
A4-21	Time constant without air tank (quick)	0 to 65535	0	☆
A4-22	Frequency suppression coefficient without air tank (quick)	0 to 65535	0	☆
A4-23	Time constant without air tank (slow)	0 to 65535	0	☆
A4-24	Frequency suppression coefficient without air tank (slow)	0 to 65535	0	☆
A4-25	Control pressure filter time	0 to 10000 ms	3000	☆
Group A5: Control Optimization				
A5-00	DPWM switchover frequency upper limit	0.00 Hz to F0-10 (Maximum frequency)	12.00 Hz	☆
A5-01	PWM modulation mode	0: Asynchronous modulation 1: Synchronous modulation	0	☆
A5-02	Dead zone compensation	0: Disabled 1: Enabled	1	★

Appendix A Parameter Table

Param. No.	Param. Name	Setting Range	Default	Property
A5-03	Random PWM depth	0: Random PWM invalid 1 to 10: PWM carrier random depth	0	☆
A5-04	Fast current limit	0: Disabled 1: Enabled	1 0 (Asynchronous motor in SVC mode)	☆
A5-05	Sampling delay	1 to 13	5	☆
A5-06	Undervoltage threshold	60 to 140%	100.0%	☆
A5-07	SVC optimization	0: No optimization 1: Optimization mode 1 2: Optimization mode 2	1	★
Group A6: AI Curve Setting				
A6-00	AI curve 4 minimum input	-10.00 V to A6-02 (AI curve 4 inflection 1 input)	0.00 V	☆
A6-01	Corresponding percentage of AI curve 4 minimum input	-100.0% to +100.0%	0.0%	☆
A6-02	AI curve 4 inflection 1 input	A6-00 to A6-04	3.00 V	☆
A6-03	Corresponding percentage of AI curve 4 inflection 1 input	-100.0% to +100.0%	30.0%	☆
A6-04	AI curve 4 inflection 2 input	A6-02 to A6-06	6.00 V	☆
A6-05	Corresponding percentage of AI curve 4 inflection 2 input	-100.0% to +100.0%	60.0%	☆
A6-06	AI curve 4 maximum input	A6-06 to +10.00V	10.00 V	☆
A6-07	Corresponding percentage of AI curve 4 maximum input	-100.0% to +100.0%	100.0%	☆
A6-08	AI curve 5 minimum input	-10.00 V to A6-10 (AI curve 5 inflection 1 input)	-10.00 V	☆
A6-09	Corresponding percentage of AI curve 5 minimum input	-100.0% to +100.0%	-100.0%	☆
A6-10	AI curve 5 inflection 1 input	A6-08 to A6-12	-3.00 V	☆
A6-11	Corresponding percentage of AI curve 5 inflection 1 input	-100.0% to +100.0%	-30.0%	☆
A6-12	AI curve 5 inflection 2 input	A6-10 to A6-14	3.00 V	☆
A6-13	Corresponding percentage of AI curve 5 inflection 2 input	-100.0% to +100.0%	30.0%	☆

Param. No.	Param. Name	Setting Range	Default	Property
A6-14	AI curve 5 maximum input	A6-12 (AI curve 5 inflection 2 input) to +10.00V	10.00 V	☆
A6-15	Corresponding percentage of AI curve 5 maximum input	-100.0% to +100.0%	100.0%	☆
A6-16	AI1 gain	-10.00 to +10.00	1.00	☆
A6-17	AI1 zero offset coefficient	-100.0% to +100.0%	0.0%	☆
A6-18	AI2 gain	-10.00 to +10.00	1.00	☆
A6-19	AI2 zero offset coefficient	-100.0% to +100.0%	0.0%	☆
A6-24	Jump point of AI1 input corresponding setting	-100.0% to 100.0%	0.0%	☆
A6-25	Jump amplitude of AI1 input corresponding setting	0.0% to 100.0%	0.5%	☆
A6-26	Jump point of AI2 input corresponding setting	-100.0% to 100.0%	0.0%	☆
A6-27	Jump amplitude of AI2 input corresponding setting	0.0% to 100.0%	0.5%	☆
Group A8: Air Compressor Control Parameters				
A8-00	Test mode	0: Normal mode 1: Tooling test mode 2: Manual unloading mode 1 3: Manual unloading mode 2	0	☆
A8-01	Loading delay	0s to 100s	8s	☆
A8-02	Pre-warning delay	0 to 65535h	0h	☆
A8-03	Pressure sensor function	0: AI3 as the pressure source 1: AI2 as the pressure source	0	☆
A8-04	Temperature sensor function	0: Temperature sensor as sensor 1 1: Temperature sensor as sensor 2	0	☆
A8-05	Pressure sensor measuring range	0.10 Mpa to 3.50 Mpa	1.60 Mpa	☆
A8-07	Constant pressure setting value	0.00 Mpa to 1.60 Mpa	0.70 Mpa	☆
A8-08	Unloading pressure setting value	0.00 Mpa to 1.60 Mpa	0.80 Mpa	☆
A8-09	Wakeup pressure (with-load)	0.00 Mpa to 1.60 Mpa	0.60 Mpa	☆
A8-10	Stop pressure setting value (protection pressure)	0.00 Mpa to 1.60 Mpa	0.90 Mpa	☆
A8-11	Pre-warning pressure setting value	0.00 Mpa to 1.60 Mpa	0.85 Mpa	☆

Appendix A Parameter Table

Param. No.	Param. Name	Setting Range	Default	Property
A8-12	Temperature at stop	0 to 200°C	110°C	☆
A8-13	Pre-warning temperature	0 to 200°C	105°C	☆
A8-14	Wakeup time	0 to 100s	0s	☆
A8-15	Preparation time before stop	0 to 100s	20s	☆
A8-16	Lock time at stop	0 to 100s	20s	☆
A8-17	Constant temperature setting value	0 to 200°C	80°C	☆
A8-18	Fan stop temperature	0 to 200°C	75°C	☆
A8-19	Fan startup temperature	0 to 200°C	85°C	☆
A8-20	Pre-operation frequency	0.00 Hz to 155.00 Hz	60.00 Hz	☆
A8-21	Pre-operation time	0 to 9999s	10s	☆
A8-22	Hibernating judgment time	0 to 9999s	20s	☆
A8-23	Air filter maintenance setting time	0 to 65535h	2000h	☆
A8-24	Oil filter maintenance setting time	0 to 65535h	2000h	☆
A8-25	Oil gas separating maintenance setting time	0 to 65535h	2000h	☆
A8-26	Motor lubricating grease maintenance setting time	0 to 65535h	2000h	☆
A8-27	Lubricant maintenance setting time	0 to 65535h	2000h	☆
A8-28	Air filter running time	0 to 65535h	0h	☆
A8-29	Oil filter running time	0 to 65535h	0h	☆
A8-30	Oil gas separating running time	0 to 65535h	0h	☆
A8-31	Motor lubricating grease running time	0 to 65535h	0h	☆
A8-32	Lubricating oil applying time	0 to 65535h	0h	☆
A8-33	Hibernating pressure setting value	0.00 Mpa to 3.50 Mpa	0.75 Mpa	☆
A8-34	Hibernating judgment time upon unloading	0 to 9999s	5s	☆

Param. No.	Param. Name	Setting Range	Default	Property
A8-35	Equipment fault action selection 0	Ones: Solenoid valve overcurrent (E95) 0: Coast to stop 2: Restart allowed 5: Canceled Tens: Phase sequence abnormal (E96) 0: Coast to stop 5: Canceled Hundreds: Output phase loss of mains frequency cooling blower (E97) 0: Coast to stop 2: Restart allowed 5: Canceled Thousands: Reserved Ten thousands: Reserved	55202 0: Coast to stop 2: Restart allowed 5: Canceled	☆
A8-39	Output current calibration coefficient	70.0 to 120.0	100.0	☆
A8-40	Output power calibration coefficient	70.0 to 120.0	100.0	☆
A8-41	Pressure calibration coefficient	0.0 to 200.0	100.0	☆
A8-42	Temperature calibration coefficient	0.0 to 200.0	100.0	☆
A8-43	Accumulative with-load running time	0 to 65535h	0h	☆
A8-44	Running time under pressure pre-warning	0 to 65535h	0h	☆
A8-45	Running time under temperature pre-warning	0 to 65535h	0h	☆
A8-46	Enabling bit of pressure and temperature sensor 2	Ones: Pressure 2 0: Disabled 1: Enabled Tens: Temperature 2 0: Disabled 1: Enabled	00	☆
A8-47	Set pre-warning value of pressure 2	0 to 65535 Mpa	0 Mpa	☆
A8-48	Set protection value of pressure 2	0 to 65535 Mpa	0 Mpa	☆
A8-49	Set pre-warning value of temperature 2	0 to 65535°C	0°C	☆
A8-50	Set protection value of temperature 2	0 to 65535°C	0°C	☆
A8-51	Jog command for mains frequency cooling blower	0 to 65535	0	☆
A8-52	Special function enabling bit	0 to 65535	1	☆

Appendix A Parameter Table

Param. No.	Param. Name	Setting Range	Default	Property
A8-53	Set low temperature value	-10 to 25°C	0°C	☆
A8-54	Warm-up exiting setting value	0 to 30°C	5°C	☆
A8-55	Warm-up frequency setting value	0.00 to F0-12	10.00 Hz	☆
A8-56	Frequency lower limit function	0 to 1	0	☆
A8-57	Immediate stop function	0 to 1	0	☆
A8-63	Automatic displacement function	0: Disabled 1: Enabled	0	☆
A8-64	Start pressure	0.00 Mpa to 655.35 Mpa	0.00 Mpa	☆
A8-65	Start frequency	0.00 Hz to 655.35 Hz	0.00 Hz	☆
A8-66	End pressure	0.00 Mpa to 655.35 Mpa	0.00 Mpa	☆
A8-67	End frequency	0.00 Hz to 655.35 Hz	0.00 Hz	☆
A8-68	Pre-warning stop setting time	0 to 65535h	100h	☆
A8-69	Accumulative running time	0 min to 65535min	0 min	☆
A8-70	Hibernating mode judgment	0: Based on frequency lower limit 1: Based on hibernating pressure 2: Disabled	0	☆
A8-71	24 V output control	0: Disabled 1: Enabled	1	☆
A8-72	Mains frequency cooling blower control	0: Disabled 1: Enabled	1	☆
A8-73	Set rated current of mains frequency cooling blower	0.2 A to 5.0 A	2.1 A	☆
A8-74	Overload judgment time of mains frequency cooling blower	0 to 3000s	0s	☆
A8-75	Pump pressure detection delay	0 to 60000s	10s	☆
A8-76	Pump pressure fault judgment delay	0 to 60000s	10s	☆
A8-80	Noise treatment	0 to 1	0	☆
A8-81	Random PWM carrier frequency lower limit	1.0 to 3.0	2.0	☆
A8-82	Carrier frequency switching point 1 (acceleration)	2.0 to 100.0	3.0	☆

Param. No.	Param. Name	Setting Range	Default	Property
A8-83	Carrier frequency switching point 2 (deceleration)	3.0 to 99.0	5.0	☆
A8-84	Closed-loop current	0 to 1	0	☆
A8-85	Closed-loop current value	1 to 200	100	☆
A8-86	Closed-loop current switching frequency	0.1 to 50.0	5.0	☆
Group A9: Vector Control Supplementary Parameters				
A9-00	Online auto-tuning of rotor time constant (asynchronous motor)	0: Disabled 1: Enabled	0	☆
A9-04	Maximum torque limit coefficient of weaken flux field in SVC/FVC mode	30 to 150	80	☆
A9-05	Speed filter of asynchronous motor in SVC mode	5 ms to 32 ms	15 ms	☆
A9-06	Speed feedback operation of asynchronous motor speed control in SVC mode	0: No operation 1: Minimum synchronization frequency limited based on load change 2 and 3: Fixed current output at low-speed running	0	☆
A9-07	Magnetic field adjusting band of asynchronous motor in SVC mode	0 Hz to 8.0 Hz	2.0 Hz	☆
A9-08	Current at low-speed running of asynchronous motor in SVC mode	30 to 170	100	☆
A9-09	Switchover frequency of fixed current output of asynchronous motor in SVC mode	2.0 Hz to 100.0 Hz	3.0 Hz	☆
A9-10	Speed fluctuation suppression coefficient of asynchronous motor in SVC mode	0 to 6	3	☆
A9-11	Acceleration/Deceleration time of asynchronous motor in SVC mode	0.1 to 3000.0s	20.0s	☆

Appendix A Parameter Table

Param. No.	Param. Name	Setting Range	Default	Property
A9-12	Quick auto-tuning of stator resistance before asynchronous motor startup	0: Disabled 1: Enabled	0	☆
A9-13	Stator resistance coefficient 1 by asynchronous motor quick auto-tuning	0 to 65535	0:	★
A9-14	Stator resistance coefficient 2 by asynchronous motor quick auto-tuning	0 to 65535	0	★
A9-15	Synchronous motor energy-saving control	0 to 10	0	☆
A9-16	Asynchronous motor energy-saving control	0: Disabled 1: Enabled	1	★
A9-17	Synchronous motor real-time angle	0 to 65535	0	●
A9-18	Initial position angle detection of synchronous motor	0: Detection always 1: No detection 2: Detection at first-time running	0	☆
A9-20	Weaken flux mode	0: Automatic 1: PMSM adjust voltage angle weaken flux 2: PMSM adjust axis D current (Id) weaken flux 3: Disabled	1	★
A9-21	Weaken flux gain of synchronous motor	0 to 50	5	☆
A9-22	Output voltage limit margin of synchronous motor	0% to 50%	5%	☆
A9-23	Maximum force gain of synchronous motor	20% to 300%	100%	☆
A9-24	Excitation current gain of synchronous motor	40% to 200%	100%	☆
A9-25	Speed evaluation integral gain of synchronous motor in SVC mode	5 to 1000	30	☆
A9-26	Speed evaluation proportional gain of synchronous motor in SVC mode	5 to 300	20	☆
A9-27	Estimated speed filter of synchronous motor in SVC mode	10 to 2000	100	☆

Param. No.	Param. Name	Setting Range	Default	Property
A9-28	Minimum carrier frequency of synchronous motor in SVC mode	0.8 kHz to F0-15 (Carrier frequency)	2.0 kHz	☆
A9-29	Synchronous motor excitation current t low-speed running	0% to 80%	30%	☆
A9-35	1st fault subcode	0 to 65535	0:	●
A9-36	2nd fault subcode	0 to 65535	0:	●
A9-37	3rd fault subcode	0 to 65535	0:	●
Group AC: AI/AO Correction				
AC-00	AI1 measured voltage 1	-10.000 V to +10.000 V	Factory-corrected	☆
AC-01	AI1 displayed voltage 1	-10.000 V to +10.000 V	Factory-corrected	☆
AC-02	AI1 measured voltage 2	-10.000 V to +10.000 V	Factory-corrected	☆
AC-03	AI1 displayed voltage 2	-10.000 V to +10.000 V	Factory-corrected	☆
AC-04	AI2 measured voltage 1 (P2+/P2-)	-10.000 V to +10.000 V	Factory-corrected	☆
AC-05	AI2 displayed voltage 1 (P2+/P2-)	-10.000 V to +10.000 V	Factory-corrected	☆
AC-06	AI2 measured voltage 2 (P2+/P2-)	-10.000 V to +10.000 V	Factory-corrected	☆
AC-07	AI2 displayed voltage 2 (P2+/P2-)	-10.000 V to +10.000 V	Factory-corrected	☆
AC-08	AI3 measured voltage 1 (P1+/P1-)	-10.000 V to +10.000 V	Factory-corrected	☆
AC-09	AI3 displayed voltage 1 (P1+/P1-)	-10.000 V to +10.000 V	Factory-corrected	☆
AC-10	AI3 measured voltage 2 (P1+/P1-)	-10.000 V to +10.000 V	Factory-corrected	☆
AC-11	AI3 displayed voltage 2 (P1+/P1-)	-10.000 V to +10.000 V	Factory-corrected	☆
AC-12	AO1 measured voltage 1	-10.000 V to +10.000 V	Factory-corrected	☆
AC-13	AO1 target voltage 1	-10.000 V to +10.000 V	Factory-corrected	☆
AC-14	AO1 measured voltage 2	-10.000 V to +10.000 V	Factory-corrected	☆
AC-15	AO1 target voltage 2	-10.000 V to +10.000 V	Factory-corrected	☆
AC-20	PT100 measured voltage 1	-3.300 V to +3.300 V	Factory-corrected	☆
AC-21	PT100 target voltage 1	-3.300 V to +3.300 V	Factory-corrected	☆

Appendix A Parameter Table

Param. No.	Param. Name	Setting Range	Default	Property
AC-22	PT100 measured voltage 2	-3.300 V to +3.300 V	Factory-corrected	☆
AC-23	PT100 target voltage 2	-3.300 V to +3.300 V	Factory-corrected	☆
AC-24	PT1000 measured voltage 1	-3.300 V to +3.300 V	Factory-corrected	☆
AC-25	PT1000 target voltage 1	-3.300 V to +3.300 V	Factory-corrected	☆
AC-26	PT1000 measured voltage 2	-3.300 V to +3.300 V	Factory-corrected	☆
AC-27	PT1000 target voltage 2	-3.300 V to +3.300 V	Factory-corrected	☆
AC-28	AO1 measured current 1	0 mA to 20 mA	Factory-corrected	☆
AC-29	AO1 target current 1	0 mA to 20 mA	Factory-corrected	☆
AC-30	AO1 target current 2	0 mA to 20 mA	Factory-corrected	☆
AC-31	AO1 measured current 2	0 mA to 20 mA	Factory-corrected	☆
Group AF: Process Data Address Mapping				
AF-00	RPDO1-SubIndex0-H	0x0000 to 0xFFFF	0x0000	☆
AF-01	RPDO1-SubIndex0-L	0x0000 to 0xFFFF	0x0000	☆
AF-02	RPDO1-SubIndex1-H	0x0000 to 0xFFFF	0x0000	☆
AF-03	RPDO1-SubIndex1-L	0x0000 to 0xFFFF	0x0000	☆
AF-04	RPDO1-SubIndex2-H	0x0000 to 0xFFFF	0x0000	☆
AF-05	RPDO1-SubIndex2-L	0x0000 to 0xFFFF	0x0000	☆
AF-06	RPDO1-SubIndex3-H	0x0000 to 0xFFFF	0x0000	☆
AF-07	RPDO1-SubIndex3-L	0x0000 to 0xFFFF	0x0000	☆
AF-08	RPDO2-SubIndex0-H	0x0000 to 0xFFFF	0x0000	☆
AF-09	RPDO2-SubIndex0-L	0x0000 to 0xFFFF	0x0000	☆
AF-10	RPDO2-SubIndex1-H	0x0000 to 0xFFFF	0x0000	☆
AF-11	RPDO2-SubIndex1-L	0x0000 to 0xFFFF	0x0000	☆
AF-12	RPDO2-SubIndex2-H	0x0000 to 0xFFFF	0x0000	☆
AF-13	RPDO2-SubIndex2-L	0x0000 to 0xFFFF	0x0000	☆
AF-14	RPDO2-SubIndex3-H	0x0000 to 0xFFFF	0x0000	☆
AF-15	RPDO2-SubIndex3-L	0x0000 to 0xFFFF	0x0000	☆
AF-16	RPDO3-SubIndex0-H	0x0000 to 0xFFFF	0x0000	☆
AF-17	RPDO3-SubIndex0-L	0x0000 to 0xFFFF	0x0000	☆
AF-18	RPDO3-SubIndex1-H	0x0000 to 0xFFFF	0x0000	☆
AF-19	RPDO3-SubIndex1-L	0x0000 to 0xFFFF	0x0000	☆
AF-20	RPDO3-SubIndex2-H	0x0000 to 0xFFFF	0x0000	☆
AF-21	RPDO3-SubIndex2-L	0x0000 to 0xFFFF	0x0000	☆
AF-22	RPDO3-SubIndex3-H	0x0000 to 0xFFFF	0x0000	☆
AF-23	RPDO3-SubIndex3-L	0x0000 to 0xFFFF	0x0000	☆
AF-24	RPDO4-SubIndex0-H	0x0000 to 0xFFFF	0x0000	☆
AF-25	RPDO4-SubIndex0-L	0x0000 to 0xFFFF	0x0000	☆

Param. No.	Param. Name	Setting Range	Default	Property
AF-26	RPDO4-SubIndex1-H	0x0000 to 0xFFFF	0x0000	☆
AF-27	RPDO4-SubIndex1-L	0x0000 to 0xFFFF	0x0000	☆
AF-28	RPDO4-SubIndex2-H	0x0000 to 0xFFFF	0x0000	☆
AF-29	RPDO4-SubIndex2-L	0x0000 to 0xFFFF	0x0000	☆
AF-30	RPDO4-SubIndex3-H	0x0000 to 0xFFFF	0x0000	☆
AF-31	RPDO4-SubIndex3-L	0x0000 to 0xFFFF	0x0000	☆
AF-32	TPDO1-SunIndex0-H	0x0000 to 0xFFFF	0x0000	☆
AF-33	TPDO1-SunIndex0-L	0x0000 to 0xFFFF	0x0000	☆
AF-34	TPDO1-SunIndex1-H	0x0000 to 0xFFFF	0x0000	☆
AF-35	TPDO1-SunIndex1-L	0x0000 to 0xFFFF	0x0000	☆
AF-36	TPDO1-SunIndex2-H	0x0000 to 0xFFFF	0x0000	☆
AF-37	TPDO1-SunIndex2-L	0x0000 to 0xFFFF	0x0000	☆
AF-38	TPDO1-SunIndex3-H	0x0000 to 0xFFFF	0x0000	☆
AF-39	TPDO1-SunIndex3-L	0x0000 to 0xFFFF	0x0000	☆
AF-40	TPDO2-SunIndex0-H	0x0000 to 0xFFFF	0x0000	☆
AF-41	TPDO2-SunIndex0-L	0x0000 to 0xFFFF	0x0000	☆
AF-42	TPDO2-SunIndex1-H	0x0000 to 0xFFFF	0x0000	☆
AF-43	TPDO2-SunIndex1-L	0x0000 to 0xFFFF	0x0000	☆
AF-44	TPDO2-SunIndex2-H	0x0000 to 0xFFFF	0x0000	☆
AF-45	TPDO2-SunIndex2-L	0x0000 to 0xFFFF	0x0000	☆
AF-46	TPDO2-SunIndex3-H	0x0000 to 0xFFFF	0x0000	☆
AF-47	TPDO2-SunIndex3-L	0x0000 to 0xFFFF	0x0000	☆
AF-48	TPDO3-SunIndex0-H	0x0000 to 0xFFFF	0x0000	☆
AF-49	TPDO3-SunIndex0-L	0x0000 to 0xFFFF	0x0000	☆
AF-50	TPDO3-SunIndex1-H	0x0000 to 0xFFFF	0x0000	☆
AF-51	TPDO3-SunIndex1-L	0x0000 to 0xFFFF	0x0000	☆
AF-52	TPDO3-SunIndex2-H	0x0000 to 0xFFFF	0x0000	☆
AF-53	TPDO3-SunIndex2-L	0x0000 to 0xFFFF	0x0000	☆
AF-54	TPDO3-SunIndex3-H	0x0000 to 0xFFFF	0x0000	☆
AF-55	TPDO3-SunIndex3-L	0x0000 to 0xFFFF	0x0000	☆
AF-56	TPDO4-SunIndex0-H	0x0000 to 0xFFFF	0x0000	☆
AF-57	TPDO4-SunIndex0-L	0x0000 to 0xFFFF	0x0000	☆
AF-58	TPDO4-SunIndex1-H	0x0000 to 0xFFFF	0x0000	☆
AF-59	TPDO4-SunIndex1-L	0x0000 to 0xFFFF	0x0000	☆
AF-60	TPDO4-SunIndex2-H	0x0000 to 0xFFFF	0x0000	☆
AF-61	TPDO4-SunIndex2-L	0x0000 to 0xFFFF	0x0000	☆
AF-62	TPDO4-SunIndex3-H	0x0000 to 0xFFFF	0x0000	☆
AF-63	TPDO4-SunIndex3-L	0x0000 to 0xFFFF	0x0000	☆
AF-66	Number of valid RPD DOs	0x0000 to 0xFFFF	0x0000	●
AF-67	Number of valid TP DOs	0x0000 to 0xFFFF	0x0000	●

Appendix A Parameter Table

Param. No.	Param. Name	Setting Range	Default	Property
Group B0: Control Mode, Linear Speed, and Winding Diameter Parameters				
B0-00	Tension control mode	0: Disabled 1: Open-loop torque control 2: Closed-loop speed control 3: Closed-loop torque control 4: Constant linear speed control	0	★
B0-01	Winding mode	0: Winding 1: Unwinding	0	☆
B0-02	Unwinding reverse tightening selection	0: Disabled 0.01 m/min to 50.00 m/min: Reverse tightening linear speed	0	☆
B0-03	Mechanical transmission ratio	0.01 to 300.00	1.00	☆
B0-04	Line speed setting channel	0: No input 1: AI1 2: AI2 4: Pulse input 5: Communication setting (1000H) 6: Communication setting (731AH)	0	★
B0-05	Maximum linear speed	0.1 m/min to 6500.0 m/min	1000.0 m/min	☆
B0-06	Minimum linear speed for winding diameter calculation	0.1 m/min to 6500.0 m/min	20.0 m/min	☆
B0-07	Winding diameter calculation method	0: Calculated based on linear speed 1: Calculated based on accumulative thickness 2: AI1 3: AI2 5: Pulse input (DIO1)	0	★
B0-08	Maximum winding diameter	1 mm to 6000.0mm	500.0 mm	☆
B0-09	Reel diameter	1 mm to 6000.0mm	100.0 mm	☆
B0-10	Setting channel of initial winding diameter	0: B0-11 (Initial winding diameter 1) to B0-13 (Initial winding diameter 3) 1: AI1 2: AI2	0	★
B0-11	Initial winding diameter 1	1 mm to 6000.0mm	100.0 mm	☆
B0-12	Initial winding diameter 2	1 mm to 6000.0mm	100.0 mm	☆
B0-13	Initial winding diameter 3	1 mm to 6000.0mm	100.0 mm	☆
B0-14	Current winding diameter	1 mm to 6000.0mm	100.0 mm	☆
B0-15	Winding diameter filter time	0.00s to 10.00s	5.00s	☆

Param. No.	Param. Name	Setting Range	Default	Property
B0-16	Winding diameter change rate	0: Disabled 0.1 mm to 10.0 mm	1.0	☆
B0-17	Winding diameter change direction limit	0: Disabled 1: Decrease inhibited during winding, and increase inhibited during unwinding	0	☆
B0-18	Winding diameter reset during running	0: Disabled 1: Enabled	0:	☆
B0-19	Pre-drive speed gain	-100.0% to +100.0%	0.0%	☆
B0-20	Pre-drive torque limit source	0: F2-09 (Torque upper limit source in speed control (electric)) 1: Tension-based	1	★
B0-21	Pre-drive torque correction	-100.0% to +100.0%	0.0%	☆
B0-22	Pre-drive winding diameter calculation delay	0.1s to 6500.0s	10.0s	☆
B0-23	Pre-drive acceleration time	0.0s to 6000.0s	0.0s	☆
B0-24	Pre-drive deceleration time	0.0s to 6000.0s	0.0s	☆
B0-25	Pre-drive winding diameter calculation function	0: Disabled 1: Enabled	0:	☆
B0-26	B0-00 = 2: Closed-loop speed limit B0-00 ≠ 2: Winding frequency limit	0.0% to 100.0%	50.0%	☆
B0-27	B0-00 = 2: Closed-loop speed limit offset	B0-00 = 2: 0.00 Hz to 100.00 Hz	5.00 Hz/%	☆
	B0-02 ≠ 2: Winding frequency limit offset	B0-02 ≠ 2: 0.00% to 100.00%		
B0-28	B0-00 = 2: Closed-loop speed limit selection B0-00 ≠ 2: Winding frequency limit function	B0-00 = 2: 0: Limit based on B0-26 and B0-27 (limited by the frequency upper limit) 1: Fixed to B0-27 B0-00 ≠ 2: 0: Disabled based on B0-26 and B0-27 (limited by the frequency upper limit) 1: Enabled based on B0-26 and B0-27	0	☆
B0-29	Number of pulses per revolution	1 to 60000	1	☆
B0-30	Revolutions per layer	1 to 10000	100	☆
B0-31	Setting channel of material thickness	0: Digital setting 1: AI1 2: AI2	0	☆
B0-32	Material thickness 0	0.01 mm to 100.00 mm	0.01 mm	☆
B0-33	Material thickness 1	0.01 mm to 100.00 mm	0.01 mm	☆

Appendix A Parameter Table

Param. No.	Param. Name	Setting Range	Default	Property
B0-34	Material thickness 2	0.01 mm to 100.00 mm	0.01 mm	☆
B0-35	Material thickness 3	0.01 mm to 100.00 mm	0.01 mm	☆
B0-36	Maximum thickness	0.01 mm to 100.00 mm	1.00 mm	☆
Group B1: Tension Setting				
B1-00	Tension setting channel	0: Set by B1-01 (Tension digital setting) 1: AI1 2: AI2 4: Pulse reference 5: Communication setting (1000H)	0	★
B1-01	Tension digital setting	0 N to 65000 N	50 N	☆
B1-02	Maximum tension	0 N to 65000 N	500 N	☆
B1-03	Zero-speed threshold	0.0% to 20.0% (maximum frequency)	0.0%	☆
B1-04	Zero-speed tension rise	0.0% to 1000.0%	0.0%	☆
B1-05	Frequency acceleration time in torque control mode	0s to 6500.0s	0.0s	☆
B1-06	Frequency deceleration time in torque mode	0s to 6500.0s	0.0s	☆
B1-07	Friction force compensation coefficient	0.0% to 50.0%	0.0%	☆
B1-08	Mechanical inertia compensation coefficient	0 N·m ² to 65535 N·m ²	0 N·m ²	☆
B1-09	Correction coefficient of acceleration inertia compensation	0.0% to 200.0%	100.0%	☆
B1-10	Correction coefficient of deceleration inertia compensation	0.0% to 200.0%	100.0%	☆
B1-11	Material density	0 kg/m ³ to 60000 kg/m ³	0 kg/m ³	☆
B1-12	Material width	0 mm to 60000 mm	0 mm	☆
B1-13	Inertia compensation exit delay	0 ms to 1000 ms	0 ms	☆
B1-15	Torque direction limit	0: No limit 1: Reverse torque inhibited	0	☆
B1-16	Torque closed-loop limit	0.0% to 100.0%	50.0%	☆
B1-17	Friction force compensation correction coefficient	-50.0% to +50.0%	0.0%	☆
B1-18	Friction force compensation curve	0: Frequency 1: Linear speed 2: Relative to maximum frequency 3: Based on running frequency	0	★
B1-19	Multi-friction force compensation torque 1	0.0% to 50.0%	0.0%	☆

Param. No.	Param. Name	Setting Range	Default	Property
B1-20	Multi-friction force compensation torque 2	0.0% to 50.0%	0.0%	☆
B1-21	Multi-friction force compensation torque 3	0.0% to 50.0%	0.0%	☆
B1-22	Multi-friction force compensation torque 4	0.0% to 50.0%	0.0%	☆
B1-23	Multi-friction force compensation torque 5	0.0% to 50.0%	0.0%	☆
B1-24	Multi-friction force compensation torque 6	0.0% to 50.0%	0.0%	☆
B1-25	Multi-friction force compensation inflection 1	0.00 Hz to the maximum frequency	0.00 Hz	☆
B1-26	Multi-friction force compensation inflection 2	0.00 Hz to the maximum frequency	0.00 Hz	☆
B1-27	Multi-friction force compensation inflection 3	0.00 Hz to the maximum frequency	0.00Hz	☆
B1-28	Multi-friction force compensation inflection 4	0.00 Hz to the maximum frequency	0.00Hz	☆
B1-29	Multi-friction force compensation inflection 5	0.00 Hz to the maximum frequency	0.00 Hz	☆
B1-30	Multi-friction force compensation inflection 6	0.00 Hz to the maximum frequency	0.00 Hz	☆
B1-31	Tension establishment	0: Disabled 1: Enabled	0	★
B1-32	Tension establishment dead zone	0.0% to 100.0%	1.0%	★
B1-33	Tension establishment frequency	0.00 Hz to F0-10 (Maximum frequency)	0.05 Hz	★
B1-34	Tension establishment Kp	0.0% to 100.0%	1.0%	★
B1-35	Tension establishment Ki	0.00s to 20.00s	10.00s	★
B1-37	Initial winding diameter free	0: Disabled 1: Enabled	0	★
B1-38	Rod length	1 mm to 65535 mm	300 mm	★
B1-39	Rod angle	1.0° to 360.0°	40.0°	★
Group B2: Taper				
B2-00	Taper curve	0: Curve 1: Linear	0	★
B2-01	Setting channel of tension taper	0: Set by B2-02 (Tension taper) 1: AI1 2: AI2	0	★

Appendix A Parameter Table

Param. No.	Param. Name	Setting Range	Default	Property
B2-02	Tension taper	0.0% to 100.0%	0.0%	☆
B2-03	Correction coefficient of taper compensation	0 mm to 10000 mm	0 mm	☆
B2-04	Closed-loop tension taper function	0: Disabled 1: Enabled	0:	★
B2-05	Setting channel of external taper AO	0: Set by B2-06 1: AI1 2: AI2	0	★
B2-06	External taper setting	0.0% to 100.0%	100.0%	☆
B2-07	Linear taper inflection quantity	0 to 5	5	☆
B2-08	Taper corresponding to minimum reel diameter	0.0% to 100.0%		☆
B2-09	Linear taper switchover point 1	B0-09 (Reel diameter) to B0-08 (Maximum winding diameter) (mm)	150.0	☆
B2-10	Taper of switchover point 1	0.0% to 100.0%	100.0	☆
B2-11	Linear taper switchover point 2	B2-09 (Linear taper switchover point 1) to B0-08 (Maximum winding diameter) (mm)	200.0	☆
B2-12	Taper of switchover point 2	0.0% to 100.0%	90.0	☆
B2-13	Linear taper switchover point 3	B2-11 (Linear taper switchover point 2) to B0-08 (Maximum winding diameter) (mm)	250.0	☆
B2-14	Taper of switchover point 3	0.0% to 100.0%	80.0	☆
B2-15	Linear taper switchover point 4	B2-13 (Linear taper switchover point 3) to B0-08 (Maximum winding diameter) (mm)	300.0	☆
B2-16	Taper of switchover point 4	0.0% to 100.0%	70.0	☆
B2-17	Linear taper switchover point 5	B2-15 (Linear taper switchover point 4) to B0-08 (Maximum winding diameter) (mm)	400.0	☆
B2-18	Taper of switchover point 5	0.0% to 100.0%	50.0	☆
B2-19	Maximum reel taper	0.0% to 100.0%	30.0	☆
B2-20	Taper corresponding to maximum reel diameter	0.0% to 100.0%	30.0%	☆

A.2 Monitoring Parameters

Param. No.	Param. Name	Min. Unit	Communication Address
Group U0: Monitoring Parameters			
U0-00	Running frequency	0.01 Hz	7000H
U0-01	Frequency reference	0.01 Hz	7001H
U0-02	Bus voltage	0.1 V	7002H
U0-03	Output voltage	1V	7003H
U0-04	Output current	0.01A	7004H
U0-05	Output power	0.1 kW	7005H
U0-06	Output torque	0.1%	7006H
U0-07	DI state	1	7007H
U0-08	DO state	1	7008H
U0-09	AI1 voltage	0.01 V	7009H
U0-10	AI2 voltage (P2+/ P2-)	0.01 V	700AH
U0-11	AI3 voltage (P1+/P1-)	0.01 V	700BH
U0-12	Count value	1	700CH
U0-13	Length value	1	700DH
U0-14	Load speed display	1 rpm	700EH
U0-15	PID reference	1	700FH
U0-16	PID feedback	1	7010H
U0-17	Low bits of accumulative power consumption	0.1	7011H
U0-18	High bits of accumulative power consumption	1	7012H
U0-19	Feedback speed	0.01 Hz	7013H
U0-20	Remaining running time	0.1 min	7014H
U0-21	AI1 voltage before correction	0.001 V	7015H
U0-22	AI2 voltage before correction (P2+/P2-)	0.001 V	7016H
U0-23	AI3 voltage before correction (P1+/P1-)	0.001 V	7017H
U0-24	Linear speed	1 rpm	7018H
U0-25	Accumulative power-on time	1 min	7019H
U0-26	Accumulative running time	0.1 min	701AH
U0-27	Pulse input frequency	1 Hz	701BH
U0-28	Communication setting	0.01%	701CH
U0-29	Encoder feedback speed	0.01 Hz	701DH
U0-30	Main frequency X display	0.01 Hz	701EH
U0-31	Auxiliary frequency Y display	0.01 Hz	701FH
U0-33	Synchronous motor rotor position	0.1°	7021H
U0-34	Motor temperature	1°C	7022H
U0-35	Target torque	0.1%	7023H
U0-37	Power factor angle	0.1°	7025H

Appendix A Parameter Table

Param. No.	Param. Name	Min. Unit	Communication Address
U0-38	ABZ position	1	7026H
U0-39	Target voltage upon V/F separation	1V	7027H
U0-40	Output voltage upon V/F separation	1 V	7028H
U0-41	DI state display	1	7029H
U0-42	DO state display	1	702AH
U0-43	DI function state display 1	1	702BH
U0-44	DI set for function state display 2	1	702CH
U0-45	Fault subcode	1	702DH
U0-46	Drive unit temperature	1°C	702EH
U0-47	Voltage before PTC correction	0.001 V	702FH
U0-48	Voltage after PTC correction	0.001 V	7030H
U0-49	Machine identification code	1	7031H
U0-56	Energy-saving control effective period	1	7038H
U0-57	Current loading time	0.1 h	7039H
U0-61	AC drive state	1	703DH
U0-62	Current fault code	1	703EH
U0-63	Actual running frequency delivered to performance software (after droop)	0.01%	703FH
U0-68	Air compressor control state flag	1	7044H
U0-69	Current displacement	1	7045H
U0-70	Current running time	1h	7046H
U0-75	Torque limit mode viewing	0.1	7047H
U0-76	Pressure sampling per unit	0.1	7048H
U0-77	Displayed pressure	0.01	7049H
U0-78	Exhaust temperature	0.1°C	704AH
U0-79	Exhaust temperature 2	0.1°C	704BH
U0-81	Solenoid valve state	1	704DH
U0-82	State remaining time	1s	704EH
U0-83	Proportion (Kp)	0.1	704FH
U0-84	Integral (Kt)	0.01	7050H
U0-85	Air compressor running state	1	7051H
U0-86	Enabling flag of restart upon fault	1	7052H
U0-87	Control pressure setting	0	7053H
U0-88	Control pressure feedback	0	7054H

Param. No.	Param. Name	Min. Unit	Communication Address
U0-89	Small valve opening tag	0	7055H
U0-91	Step size	0	7057H
U0-92	Control output	0	7058H
U0-93	Output factor	0	7059H
U0-94	Pressure deviation	0	705AH
U0-95	Protection pressure	0	705BH
Group U1: Special Process Monitoring Parameters			
U1-00	Pressure PID reference	1	7100H
U1-01	Pressure PID feedback	1	7101H
U1-02	Temperature PID reference	1	7102H
U1-03	Temperature PID feedback	1	7103H
U1-04	Voltage before temperature 1 correction (PT1+/PT1-)	0.001 V	7104H
U1-05	Voltage before temperature 2 correction (PT2+/PT2-)	0.001 V	7105H
U1-06	Voltage after temperature 1 correction (PT1+/PT1-)	0.001 V	7106H
U1-07	Voltage after temperature 2 correction (PT2+/PT2-)	0.001 V	7107H
U1-08	24 V output state	1	7108H
U1-09	Mains frequency cooling blower output state	0.01	7109H
U1-10	Motor rotation speed	0.01 rpm	710AH
U1-11	Output current of mains frequency cooling blower	0.1 A	710BH
U1-12	Low pump pressure state	1	710CH
U1-13	Second pressure	0.01 Mpa	710DH
U1-14	Warm-up flag state	0.1	710EH

INOVANCE Warranty Agreement

- 1) Inovance provides an 18-month free warranty to the equipment itself from the date of manufacturing for the failure or damage under normal use conditions.
- 2) Within the warranty period, maintenance will be charged for the damage caused by the following reasons:
 - a. Improper use or repair/modification without prior permission
 - b. Fire, flood, abnormal voltage, natural disasters and secondary disasters
 - c. Hardware damage caused by dropping or transportation after procurement
 - d. Operations not following the user instructions
 - e. Damage out of the equipment (for example, external device factors)
- 3) The maintenance fee is charged according to the latest Maintenance Price List of Inovance.
- 4) If there is any problem during the service, contact Inovance's agent or Inovance directly.
- 5) Inovance reserves the rights for explanation of this agreement.

Suzhou Inovance Technology Co., Ltd.

Address: No.16, Youxiang Road, Yuexi Town, Wuzhong District, Suzhou 215104, P.R. China

Website: <http://www.inovance.com>

Shenzhen Inovance Technology Co., Ltd.

Add.: Building E, Hongwei Industry Park, Liuxian Road, Baocheng No. 70 Zone, Bao'an District, Shenzhen

Tel: +86-755-2979 9595

Fax: +86-755-2961 9897

Service Hotline: 400-777-1260

<http://www.inovance.com>

Suzhou Inovance Technology Co., Ltd.

Add.: No. 16 Youxiang Road, Yuexi Town, Wuzhong District, Suzhou 215104, P.R. China

Tel: +86-512-6637 6666

Fax: +86-512-6285 6720

Service Hotline: 400-777-1260

<http://www.inovance.com>



19010796A02

Copyright © Shenzhen Inovance Technology Co., Ltd.