



19011097 A00

1

1. Overview

Thank you for purchasing the GL10-0016ER digital output module developed by Inovance!

This product provides 16-channel relay outputs, and is used together with the AM600CPU, GL10-RTU-ECT, GL10-RTU-COP, GL10-RTU-DP and H3U modules to expand the digital output ports.

This guide describes the specifications, characteristics and using methods of the product. Read this guide carefully before using to ensure more safe usage. You can find more information on our website (www.inovance.com).

Approvals

Certification marks on the product nameplate indicate compliance with the corresponding certificates and standards.

Certification	Mark	Directives	Standard
CE		EMC directives	2014/30/EU EN61131-2
		LVD directives	2014/35/EU EN 61010-1 EN61010-2-201
		RoHS directives	2011/65/EU EN 50581

Note:

- For more information on certification, consult our distributor or sales representative.

2. Safety Information and Precautions

- WARNING** Indicates the improper operation which, if not avoided, may cause death or serious injury.
- CAUTION** Indicates the improper operation which, if not avoided, may cause moderate or minor injury, as well as equipment damage.

In some cases, even failure to follow "Cautions" may also lead to serious consequences. Please make sure to follow both warnings and cautions, otherwise, it may cause death or serious injury, as well as product and relevant equipment and system damage.

Please keep this guide well so that it can be read when necessary and forward this guide to the end user.

During control system design

- WARNING** Provide a safety circuit outside the PLC so that the control system can still work safely once external power failure or PLC fault occurs.
- Add a fuse or circuit breaker because the module may smoke or catch fire due to long-time overcurrent caused by operation above rated current or load short-circuit.

2

During control system design

- CAUTION**
 - An emergency stop circuit, a protection circuit, a forward/reverse operation interlocked circuit, and a upper position limit and lower position limit interlocked circuit must be set in the external circuits of PLC to prevent damage to the machine.
 - To ensure safe operation, for the output signals that may cause critical accidents, please design external protection circuit and safety mechanism;
 - Once PLC CPU detects abnormality in the system, all outputs may be closed; however, when a fault occurs in the controller circuit, the output may not be under control. Therefore, it is necessary to design an appropriate external control circuit to ensure normal operation;
 - If the PLC's output units such as relays or transistors are damaged, the output may fail to switch between ON and OFF states according to the commands;
 - The PLC is designed to be used in indoor electrical environment (overvoltage category II). The power supply must have a system-level lightning protection device, assuring that overvoltage due to lightning shock can't be applied to the PLC's power supply input terminals, signal input terminals and output terminals and so forth, so as to avoid damage to the equipment.

During installation & wiring

- WARNING**
 - Installation and wiring must be carried out by the specialists who have received the necessary electrical training and understood enough electrical knowledge.
 - Disconnect all external power supplies of the system before module assemble/disassemble and wiring. Failure to do so may result in electric shock, module fault or malfunction.
 - Do not use the PLC where there are dust, oil smoke, conductive dust, corrosive or combustible gases, or exposed to high temperature, condensation, wind & rain, or subject to vibration and impact. Electric shock, fire and malfunction may also result in damage or deterioration to the product.
 - The PLC is an open-type that must be installed in a control cabinet with lock (cabinet housing must satisfy protection of over IP20). Only the personnel who have the necessary electrical training and experience can open the cabinet.
 - Install the terminal cover attached to the product before power-on or operation after wiring is completed. Failure to comply may result in electric shock.
 - Perform good insulation on terminals so that insulation distance between cables will not reduce after cables are connected to terminals. Failure to comply may result in electric shock or damage to the equipment.

- CAUTION**
 - Prevent metal filings and wire ends from dropping into ventilation holes of the PLC during installation and wiring. Failure to comply may result in fire, fault and malfunction.
 - Ensure there are no foreign matters on ventilation surface. Failure to comply may result in poor ventilation, which may cause fire, fault and malfunction.
 - Ensure the module is connected to the respective connector securely and hook the module firmly. Improper installation may result in malfunction, fault or fall-off.
 - The external wiring specification and installation method must comply with local regulations. For details, see the wiring section in this guide.
 - To ensure safety of equipment and operator, use cables with sufficient diameter and connect the cables to ground reliably.
 - Wire the module correctly after making clear of the connector type. Failure to comply may result in module and external equipment fault.
 - Tighten bolts on the terminal block in the specified torque range. If the terminal is not tight, short-circuit, fire or malfunction may be caused. If the terminal is too tight, fall-off, short-circuit, fire or malfunction may be caused.
 - If the connector is used to connect with external equipment, perform correct crimping or welding with the tool specified by manufacturer. If connection is in poor contact, short-circuit, fire or malfunction may be caused.
 - A label on the top of the module is to prevent foreign matters entering the module. Do not remove the label during wiring. Remember to remove it before system operation, facilitating ventilation.
 - Do not bundle control wires, communication wires and power cables together. They must be run with distance of more than 100 mm. Otherwise, noise may result in malfunction.
 - Select shielded cable for high-frequency signal input/output in applications with serious interference so as to enhance system anti-interference ability.

During maintenance & inspection

- WARNING**
 - Maintenance & inspection must be carried out by personnel who have the necessary electrical training and experience.
 - Do not touch the terminals while the power is on. Failure to comply may result in electric shock or malfunction.
 - Disconnect all external power supplies of the system before cleaning the module or re-tightening screws on the terminal block or screws of the connector. Failure to comply may result in electric shock.
 - Disconnect all external power supplies of the system before removing the module or connecting/removing the communication wirings. Failure to comply may result in electric shock or malfunction.

3

- CAUTION**
 - Get acquainted with the guide and ensure safety before online modification, forcible output, and RUN/STOP operation.
 - Disconnect the power supply before installing/removing the extension card.

At disposal

- CAUTION**
 - Treat scrapped module as industrial waste. Dispose the battery according to local laws and regulations.

3. Product Information

Model and Nameplate

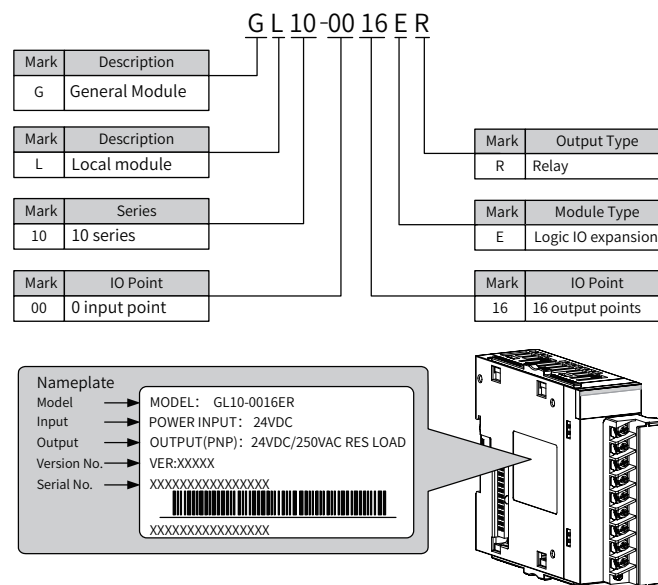

Figure 1 Description of model and nameplate

Model	Classification	Description	Applicable to
GL10-0016ER	Digital output module	16-point DO module; relay output	AM600 series, H3U series

Figure 2 External Interface

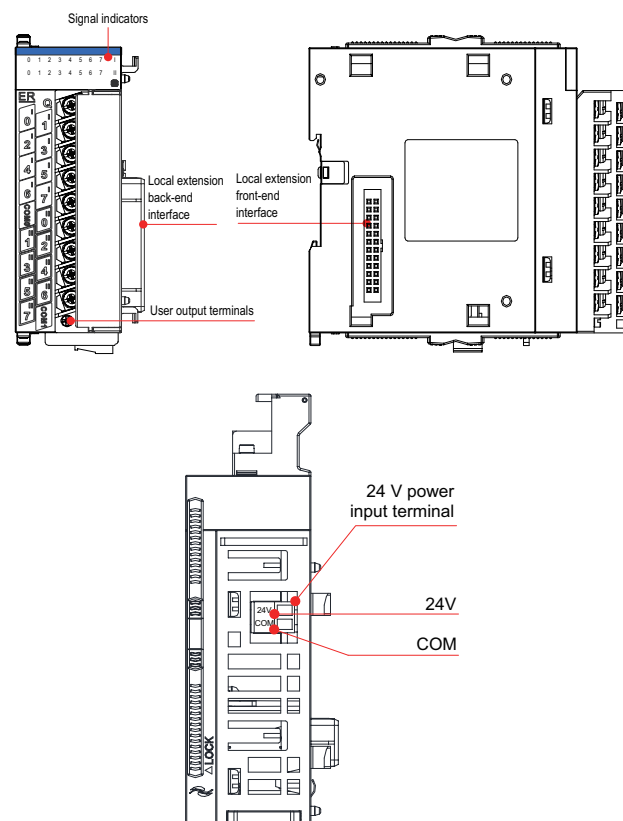

Figure 3 Diagram of the digital output modules interface

4

Interface Name	Function
User output terminals	2groups output with 8 channels in each group
Signal indicators	Corresponding to various output signal ON: output active OFF: output inactive
Local expansion module back-end interface	Connect back-end module, not supporting hot plugging
Local expansion module front-end interface	Connect front-end module, not supporting hot plugging
24 V power supply terminal	Externally connected to 24 VDC power supply

General Specifications

Item	GL10-0016ER	
Output channel	16	
Output connecting mode	16+2(COM) point wiring terminals	
Power supply of the module ^[1]	24 Vdc (-15% to +20%)	
Output type	Relay output	
Output mode	-	
Voltage of the output control circuit	110 Vac to 220 Vac	
Internal 5 V power consumption	65 mA (typical value)	
Rated current of relay	240 Vac/24 Vdc, 2 A	
Maximum leakage current when the module is turned OFF	-	
Response time when the module is turned ON	Less than 20 ms (for hardware)	
Response time when the module is turned OFF	Less than 20 ms (for hardware)	
Maximum load	Resistive load	Single-point 1 A/point
	Lamp load	Single-point 30 W
	Inductive load	220 Vac, 2 A/1 point
	Capacitive load	Not recommended
Isolation method	Mechanical isolation	
Output action display	Output indicator is ON when the relay is excited.	

[1] Power supply of the module is connected via the independent 2pin terminal.

4. Mechanical Design Reference

Mounting Dimensions

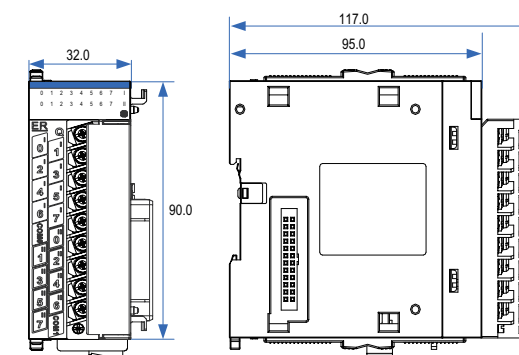

Figure 4 Mounting dimensions (in mm)

5. Electrical Design Reference

Cable Selection

Cable Name	Model	Applicable Cable Diameter		Manufacturer	Crimping Tool
		MM ²	AWG		
Y-type cable lug	TNS1.25-3	0.5-0.75	22-18	Suzhou Yuanli	RYO-8 YYT-8

Those cable lugs are applicable to digital/analog modules, and the cable rated temperature is required to be above 75 °C.

Cable Preparing

Cable preparing procedures:

- Strip back the wire outer coating by 6 mm.
- Pass the cable through the tube of proper wire size.
- Insert the exposed end into the hole of the cable lug, and then crimp it with recommended crimping tool.
- Use a heat-shrinkable tube (Φ3) of 20 mm long to wrap the copper tube of a cable lug and then perform thermal shrinkage.

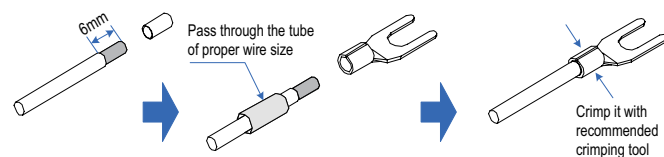

Figure 5 Diagram of cable preparing

- 5) Put the cable lug onto the terminal and tighten the screw with a screwdriver. The maximum tightening torque is 0.8 N·m.

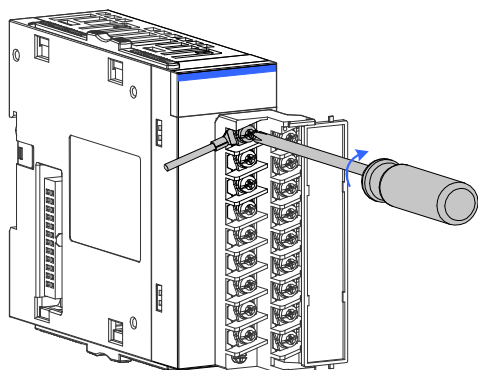

Figure 6 Connecting cable to terminal block

Terminal Arrangement of the Relay Output Module (GL10-0016ER)

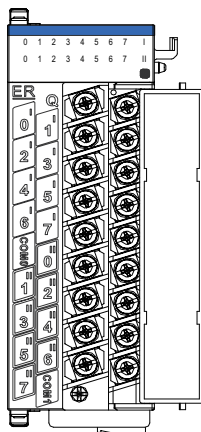

Figure 6 Terminal arrangement of the digital output module

Terminal Definition of the Relay Output Module (GL10-0016ER)

SN	Network Name	Type	Function	Remark
Interface for the 1st group of outputs				
1	Q0	Output	User output 0 in the 1st group	Relay contact
2	Q1	Output	User output 1 in the 1st group	Relay contact
3	Q2	Output	User output 2 in the 1st group	Relay contact
4	Q3	Output	User output 3 in the 1st group	Relay contact
5	Q4	Output	User output 4 in the 1st group	Relay contact
6	Q5	Output	User output 5 in the 1st group	Relay contact
7	Q6	Output	User output 6 in the 1st group	Relay contact
8	Q7	Output	User output 7 in the 1st group	Relay contact
9	COM0	Output common	Common	Common of the first group
Interface for the 2nd group of outputs				
10	Q0	Output	User output 0 in the 2nd group	Relay contact
11	Q1	Output	User output 1 in the 2nd group	Relay contact
12	Q2	Output	User output 2 in the 2nd group	Relay contact
13	Q3	Output	User output 3 in the 2nd group	Relay contact
14	Q4	Output	User output 4 in the 2nd group	Relay contact
15	Q5	Output	User output 5 in the 2nd group	Relay contact
16	Q6	Output	User output 6 in the 2nd group	Relay contact
17	Q7	Output	User output 7 in the 2nd group	Relay contact
18	COM1	Output common	Common	Common of the second group
Power connector				
1	24 V	Power input	24 Vdc power supply	24 Vdc power supply input
2	COM	Power supply common	Common	24 Vdc power supply common

External Wiring

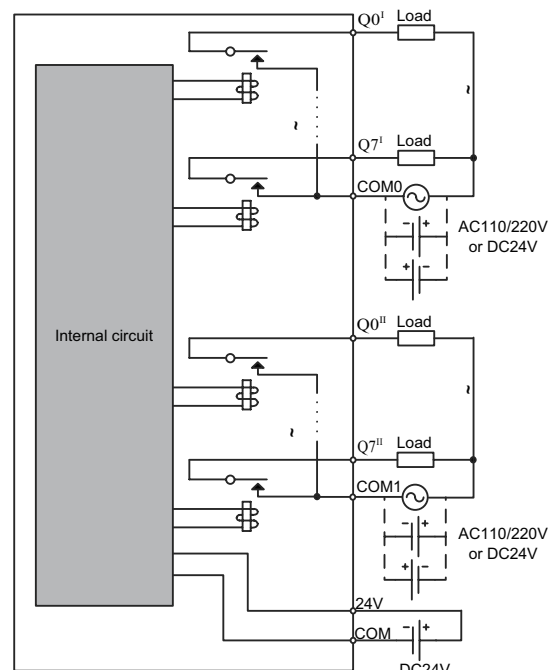

Figure 7 GL10-0016ER output wiring diagram

Wiring Precautions

- Do not bundle the terminal connection cables together with power cables (high voltage, large current) which produce strong interference signals. Separate it from other cables and avoid cabling in parallel.
- Select recommended cables and pinboards for connection. It is recommended that shielded cables be used as terminal connection cables to enhance capacity of resisting interference.

Contact Protection When Using Inductive Load

Since no internal protection circuit for relays is designed, when the inductive load is applied, large back EMF will be produced between contacts and arc discharge is also caused when the inductive load stops. This may result in contact failure or contact sag, shortening the contact lifetime. Therefore, it is recommended to use the products which have built-in relay protection circuit. For the products without built-in relay protection circuit, an external contact protection circuit can be used to reduce noises and prolong the lifetime of product.

- Relay DC Circuit

Connect a freewheel diode in parallel with the load. The freewheel diode must satisfy: ① reverse voltage is 5 to 10 times of load voltage; ② forward current is larger than load current.

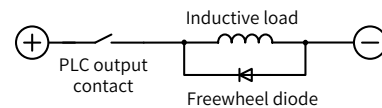

Figure 8 DC circuit contact protection when using inductive load

- Relay AC Circuit

Connect a surge absorber (or a surge suppressor, a spark suppressor and other CR composite components) in parallel with the load. The surge absorber must satisfy: ① rated voltage is applicable to all kinds of outputs; ② electrostatic capacity is about 0.1 μF; ③ resistance is about 100~200 Ω.

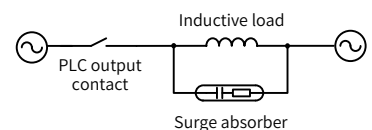

Figure 9 AC circuit contact protection when using inductive load

Contact Protection When Using Capacitive Load

When the capacitive load is applied, impulse current, 20~40 times of normal current, can occur in the case of electric shock. Please note that impulse current should not exceed the current generated when using maximum resistive load.

When using electronic circuit load such as variable-frequency drives, capacitive loads can also exist due to capacitors and others.

6. Programming Examples

Programming Example for AM600 main module + GL10-0016ER module

Use AM600CPU as the main control module and set the first channel of two groups of outputs of the GL10-0016ER to active; the usage of GL10-0016ER is described as follows:

- Create a project and perform hardware configuration as follows:

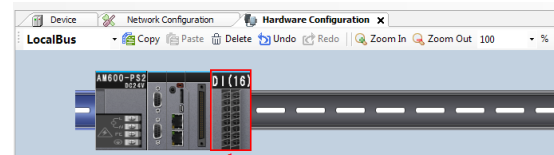

- Use ST programming language to program the GL10-0016ER module, define the mapping tags Q1_0 and Q2_0 for the first channel of each group, and set corresponding channels of mapping variables to active.

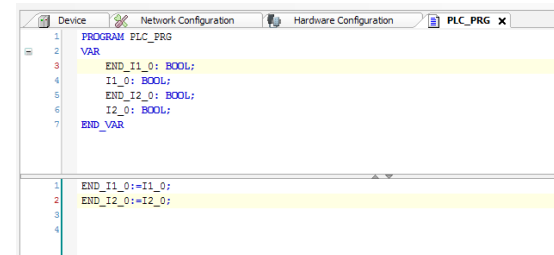

- Map the mapping tags Q1_0 and Q2_0 defined in the program to the first channel of two groups of the GL10-0016ER module respectively, shown in the following figure.

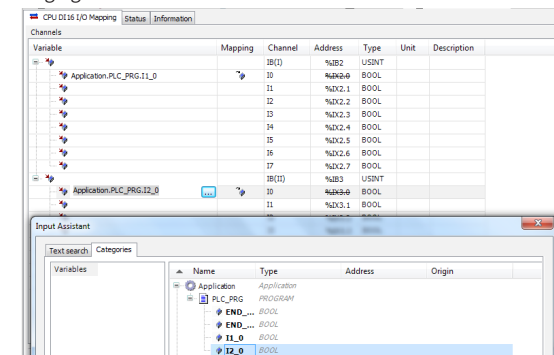

- After successful compiling, log in to download the project and run it (①Compile; ②Log in; ③Run).



Programming example for H3U + GL10-0016ER module

Use H3U as the main control module and set the first channel of the GL10-0016ER module to active; the usage of GL10-0016ER is described as follows:

- Create a project. Select "H3U". Then the system enters the main page: ① click "Configuration"; ② right-click "Network Configuration" and then click "Create a New Module Configuration"; ③ The simulation graphics of the rack to be configured appears, as shown in the figure.

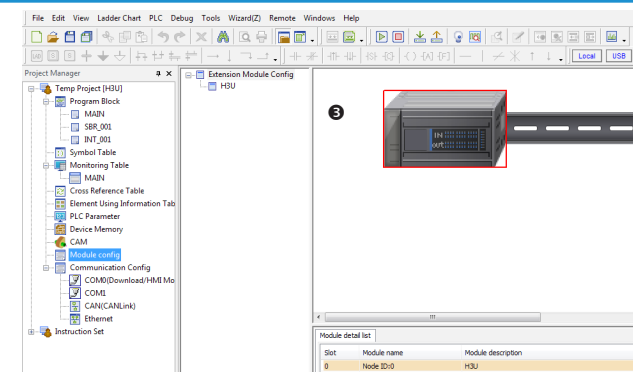
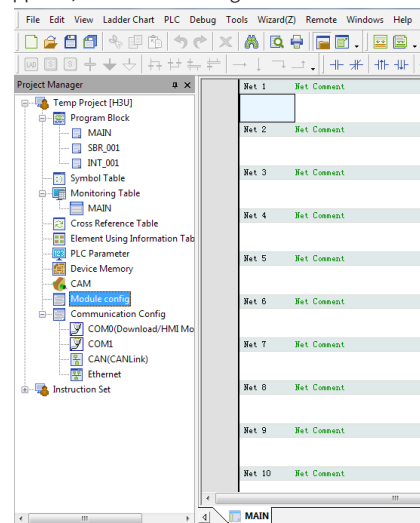

- Select the module of GL10-0016ER to be added from the module list. Double-click the module to automatically add it to the expansion rack, or use left mouse button to drag it onto the expansion rack.

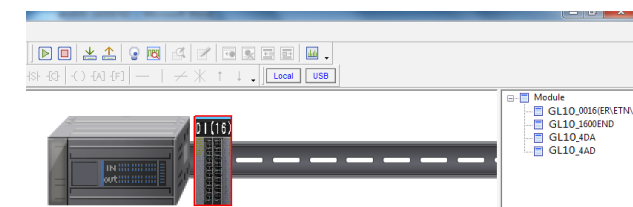

- Perform programming on outputs of GL10-0016ER by using ladder diagram.

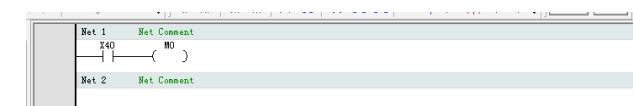

Note:

- ◆ Y represents the bit component used to control PLC's output. When a local expansion module is connected to the H3U, the Y port on the expansion module is numbered in a way that the number closely and sequentially follows the number of the Y port on the main module. For example, when the GL10-0016ER expansion module is connected to the H3U-3232MT main module, as the last series number of the Y port on the main module is Y37, series numbers of the Y port on the expansion module are programmed to Y40~Y57.
 - ◆ SN of Y ports of the expansion module starts from units position 0 in octonary system.
- After successful compiling, download the project and run it.

INOVANCE Warranty Agreement

- Inovance provides an 18-month free warranty to the equipment itself from the date of manufacturing for the failure or damage under normal use conditions.
- Within the warranty period, maintenance will be charged for the damage caused by the following reasons:
 - Improper use or repair/modification without prior permission
 - Fire, flood, abnormal voltage, natural disasters and secondary disasters
 - Hardware damage caused by dropping or transportation after procurement
 - Operations not following the user instructions
 - Damage out of the equipment (for example, external device factors)
- The maintenance fee is charged according to the latest Maintenance Price List of Inovance.
- If there is any problem during the service, contact Inovance's agent or Inovance directly.
- Inovance reserves the rights for explanation of this agreement.

Suzhou Inovance Technology Co., Ltd.

Address: No.16, Youxiang Road, Yuxei Town, Wuzhong District, Suzhou 215104, P.R. China

Website: <http://www.inovance.com>