

User Guide

H3U Series PLC

Higher Performance & Pulse Motion Control





Preface

Thank you for purchasing the H3U series programmable logic controller (PLC). It is a third-generation high-performance PLC development by Inovance based on the new-generation industrial CPU and FPGA hardware architecture and self-owned industrial embedded software design.

■ Approvals

Certification marks on the product nameplate indicate compliance with the corresponding certificates and standards.

Certification	Mark	Directives		Standard
CE		EMC directives	2014/30/EU	EN61131-2
		LVD directives	2014/35/EU	EN 61010-1 EN61010-2-201
		RoHS directives	2011/65/EU	EN 50581
TUV		-		EN 61010-1 EN61010-2-201



NOTE

- ◆ The above EMC directives are complied with only when the EMC electric installation requirements are strictly observed.
- ◆ Machines and devices used in combination with this PLC must also be CE certified and marked. The integrator who integrates the PLC with the CE mark into other devices has the responsibility of ensuring compliance with CE standards and verifying that conditions meet European standards.
- ◆ The installer of the PLC is responsible for complying with all relevant regulations for wiring, circuit fuse protection, earthing, accident prevention and electromagnetic (EMC regulations). In particular fault discrimination for preventing fire risk and solid earthing practices must be adhered to for electrical safety (also for good EMC practice).
- ◆ For more information on certification, consult our distributor or sales representative.

Contents

Preface.....	1
1 Product Information.....	4
1.1 Designation Rule and Nameplate.....	4
1.2 General Specification.....	4
1.3 Product Structure.....	6
1.4 Dimensions.....	7
2 Installation.....	9
2.1 Installation Environment.....	9
2.2 Installation Position and Space.....	9
2.3 Installation Procedure.....	10
2.4 Installation of Expansion Modules.....	11
2.5 Dismantling Connection Terminals.....	12
2.6 Installation of Lithium Cell.....	12
2.7 Installation of COM0 and Ethernet Cables.....	13
3 Wiring.....	14
3.1 I/O Terminals.....	14
3.2 Input Wiring.....	16
3.3 Output Wiring.....	18
3.4 Communication.....	20
4 Quick Setup.....	22
4.1 Tools Requirements.....	22
4.2 Hardware Connection.....	23
4.3 Installation of AutoShop.....	23
4.4 Program Download Procedure.....	25
5 Troubleshooting.....	32
5.1 System Error Code D8060.....	32
5.2 System Error Code D8061.....	32
5.3 System Error Code D8062.....	33
5.4 System Error Code D8063.....	35

5.5 System Error Code D8064	37
5.6 System Error Code D8065	38
5.7 System Error Code D8066	39
5.8 System Error Code D8067	40
Revision History	43

1 Product Information

1.1 Designation Rule and Nameplate

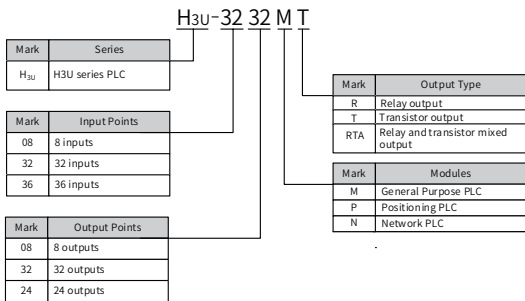

Figure 1-1 Designation rule of H_{3U}-0808PMRTA (selling stopped) , H_{3U}-3232MR/T, H_{3U}-3624MR/T

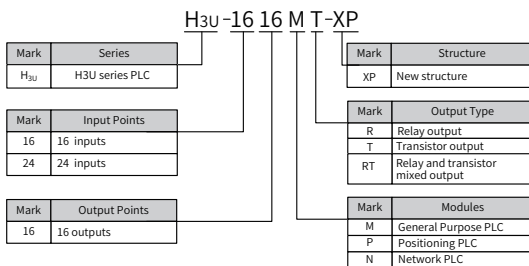

Figure 1-2 Designation rule of H_{3U}-1616MT/R-XP, H_{3U}-2416MR/T-XP

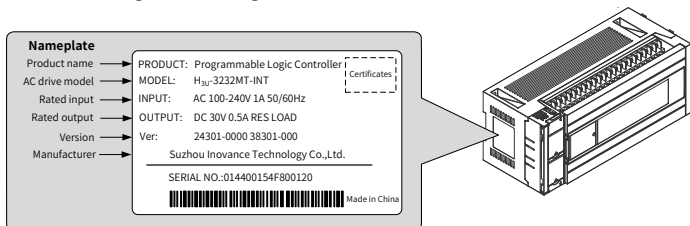

Figure 1-3 Nameplate

1.2 General Specification

PLC Model	H ₃₀ -1616MT-XP	H ₃₀ -1616MR-XP	H ₃₀ -2416MT-XP	H ₃₀ -2416MR-XP	H ₃₀ -3624MT	H ₃₀ -3624MR	H ₃₀ -3232MT	H ₃₀ -3232MR	H ₃₀ -0808PMRTA ^[8]
Category	Standard motion ^[5]								
Power Supply	220 VAC (85 to 264 VAC), 1 A								
Output voltage	24 VDC (Rated), 350 mA								
Built-in inputs	Total inputs	16	24	24	36	36	32	32	8 ^[1]
	High-speed inputs	8 x 200 kHz	8 x 200 kHz	8 x 200 kHz	8 x 200 kHz	8 x 200 kHz	8 x 200 kHz	8 x 200 kHz	3 x 200 kHz ^[2]
Built-in outputs	Total outputs	16	16	16	24	24	32	32	8 ^[3]
	High-speed outputs	5 x 200 kHz	N/A	5 x 200 kHz	N/A	5 x 200 kHz	N/A	5 x 200 kHz	3 x 500 kHz ^[4]
Output type	Transistor (NPN)	Relay ^[7]	Transistor (NPN)	Relay ^[7]	Transistor (NPN)	Relay ^[7]	Transistor (NPN)	Relay ^[7]	4 x Relay ^[7] 4 x Transistor (NPN)
Serial port	COM0(RS422/RS485), COM1(RS485), Modbus-RTU, DB9								
CAN port	CANopen/CANlink								
Ethernet ports	Modbus-TCP, RJ45								
USB (device)	Mini-B								

[1] 8 inputs = X0-X7, normal inputs

[2] 3 x 200 kHz = 3-channel A/B phase differential high-speed inputs

[3] 8 outputs = Y0-Y7, normal outputs

[4] 3 x 500 kHz = 3-channel differential high-speed outputs

[5] Supports two-axes circular and point to point interpolated

[6] Supports three-axes point to point interpolated and spiral curve

[7] Maximum output current:

Resistive load: 2 A/1 point; 8 A/4 point common terminal; 8 A/8 point common terminal

Inductive load: 220 VAC, 80 VA

Lamp load: 220 VAC, 100 W

[8] H₃₀-0808PMRTA is not for sale anymore.

1.3 Product Structure

1.3.1 H_{3U}-0808PMRTA, H_{3U}-3232MR/T, H_{3U}-3624MR/T

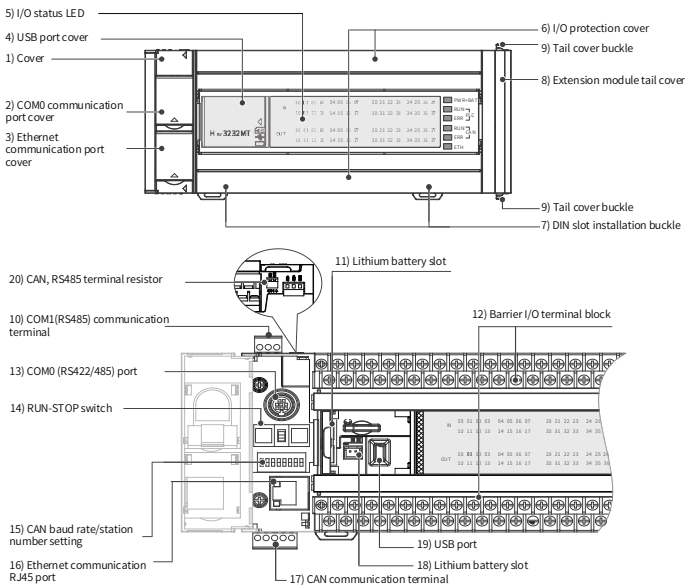

H_{3U}-0808PMRTA is not for sale anymore.

1.3.2 H_{3U}-1616MT/R-XP, H_{3U}-2416MR/T-XP

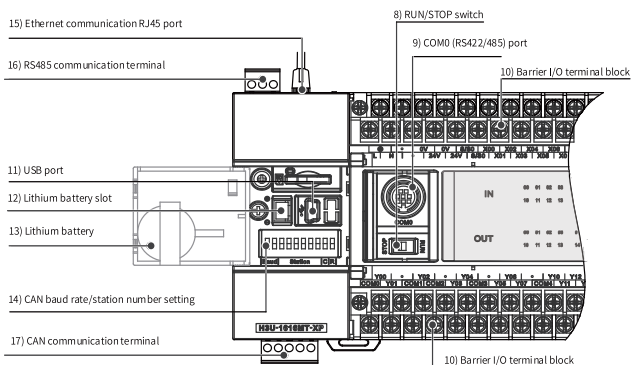
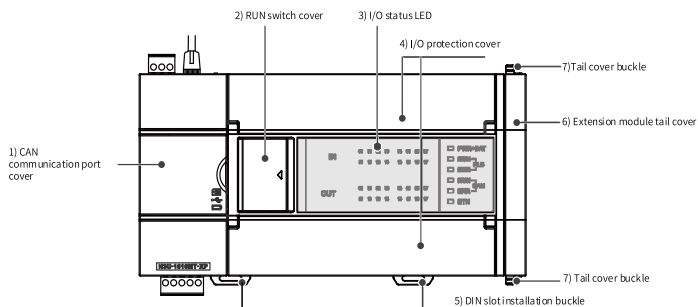

1.4 Dimensions

1.4.1 H_{3U}-0808PMRTA, H_{3U}-3232MR/T, H_{3U}-3624MR/T

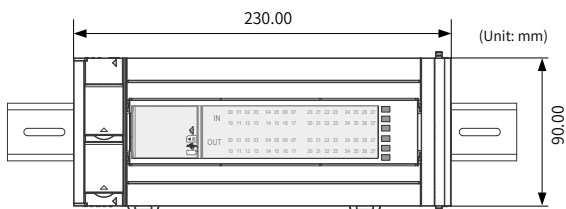

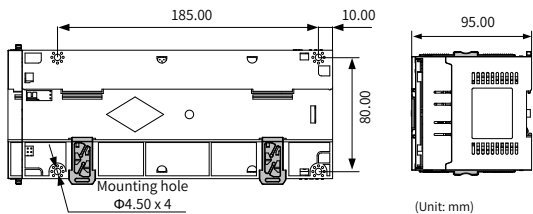

1.4.2 H_{3U}-1616MT/R-XP, H_{3U}-2416MR/T-XP

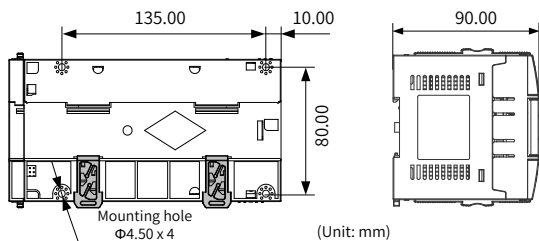
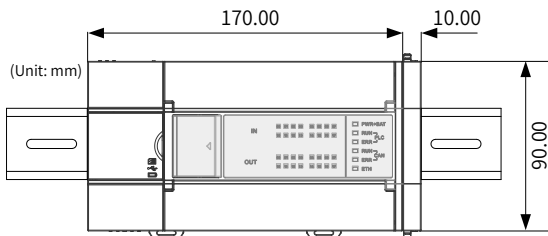

2 Installation

2.1 Installation Environment

Item	Specifications				
Ambient temperature	Running: -5-55° C, storage: -25-75° C				
Relative humidity	Running: 5-95%RH (non-condensing)				
Vibration	When DIN rail is installed	Frequency (Hz)	Acceleration (m/s ²)	One-way amplitude (mm)	Ten times in each of the X, Y and Z direction for 80 minutes
		10-57	--	0.035	
	When PLC is directly installed	57-150	4.9	--	
		10-57	--	--	
57-150	9.8	0.075			
Working environment	Do not use the PLC in environments with strong erosive and flammable gases or conductive dust.				
Elevation	Below 2000m				

2.2 Installation Position and Space

The PLC should be installed in the correct position horizontally as shown in the following figure.

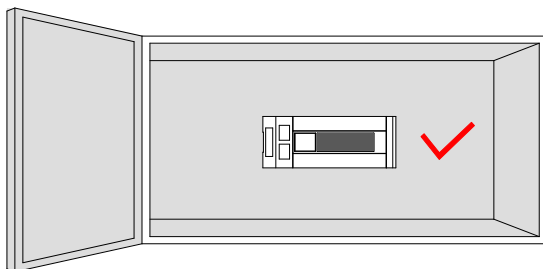

To ensure properly ventilation, the distance A between the PLC and modules should be larger than 50 mm.

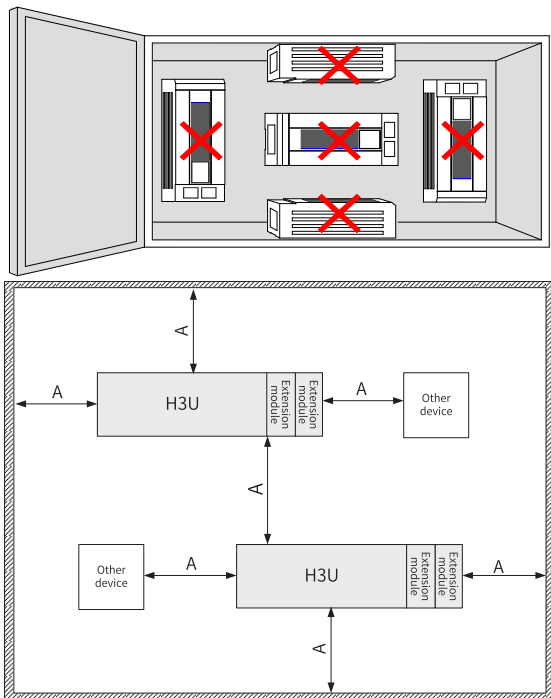

2.3 Installation Procedure

The H3U series PLC can be installed on DIN rails or mounted on wall using M4 screws.

2.3.1 Installation of DIN Rail (DIN46277, 35 mm wide)

- 1) Fix the DIN rail on the mounting surface in the control cabinet;
- 2) Clip the mounting slot on the rear side of the PLC in the upper edge of the rail horizontally as shown in the following figure;

- 3) Press the PLC in the direction B shown in the following figure until you hear the click sound. Check if the PLC is fully and vertically clipped in on the DIN rail.

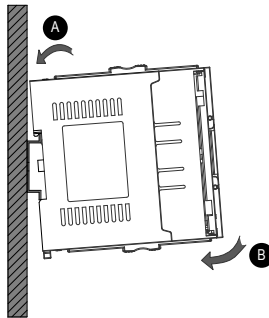

2.3.2 Mounting on Wall

Use M4 screws to fix the PLC on the installation surface in the control cabinet through the mounting holes on four corners as shown in the following figure:

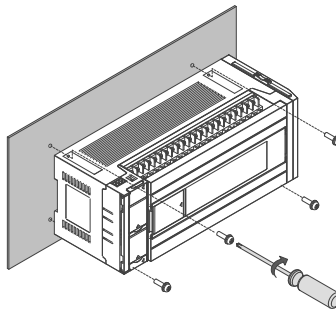

2.4 Installation of Expansion Modules

Pull the lock catch on the expansion module to the direction shown in the following figure. Push the expansion module to the PLC. Pull the lock catch back to lock it.

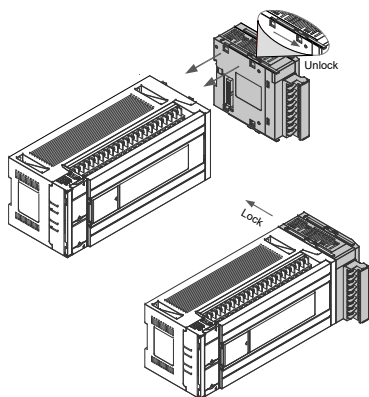

2.5 Dismantling Connection Terminals

When dismantling the barrier terminal block, loosen the screws on both sides concurrently to remove the terminal block horizontally.

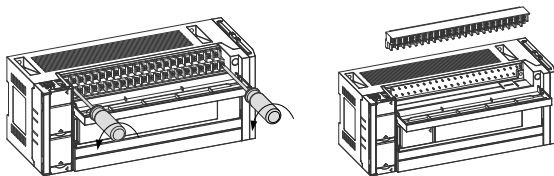

2.6 Installation of Lithium Cell

Follow the procedure to install a new lithium cell if necessary.

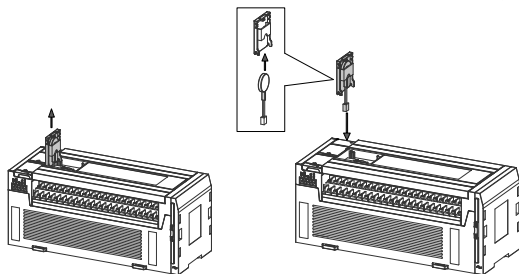

2.7 Installation of COM0 and Ethernet Cables

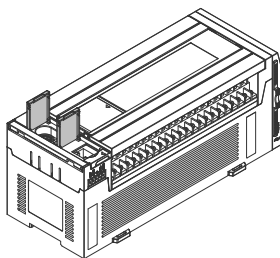

Setting of DIP switch: when you need to set the Ethernet IP address, CAN communication Baud rate and station number, you need to open the cover on the left side as shown in the following figure.

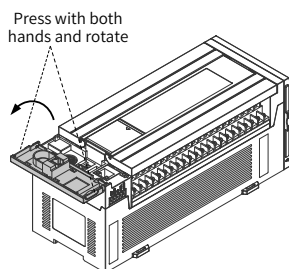

3 Wiring

3.1 I/O Terminals

3.1.1 Layout of Terminals

■ Terminals of H_{3U}-3232MT

⊕		S/S0	0V	0V	X00	X02	X04	X06	X10	X12	X14	X16	X20	X22	X24	X26	X30	X32	X34	X36	S/S1
L	N	0	24V	24V	X01	X03	X05	X07	X11	X13	X15	X17	X21	X23	X25	X27	X31	X33	X35	X37	
Y00	Y02	Y03	Y04	Y05	Y06	COM5	Y11	Y13	Y14	Y16	COM7	Y21	Y23	Y24	Y26	Y30	Y32	Y34	Y36	COM9	
COM0	Y01	COM1	COM2	COM3	COM4	Y07	Y10	Y12	COM6	Y15	Y17	Y20	Y22	COM8	Y25	Y27	Y31	Y33	Y35	Y37	

■ Terminals of H_{3U}-3624MR/T

⊕		S/S0	X0	X2	X4	X6	X10	X12	X14	X16	X20	X22	X24	X26	X30	X32	X34	X36	X40	X42	S/S1
L	N	0	X1	X3	X5	X7	X11	X13	X15	X17	X21	X23	X25	X27	X31	X33	X35	X37	X41	X43	
24V	24V	0	Y00	Y02	Y03	Y04	Y06	Y07	0	Y11	Y13	0	Y15	Y17	0	Y21	Y23	0	Y25	Y27	
0V	0V	0	COM0	Y01	COM1	COM2	Y05	COM3	COM4	Y10	Y12	COM5	Y14	Y16	COM6	Y20	Y22	COM7	Y24	Y26	

■ Terminals of H_{3U}-2416MR/T-XP

⊕		S/S0	X01	X03	X05	X07	X11	X13	X15	X17	X21	X23	X25	X27
L	N	X00	X02	X04	X06	X10	X12	X14	X16	X20	X22	X24	X26	
24V	24V	Y00	Y02	Y03	Y04	Y06	Y07	0	Y11	Y13	0	Y15	Y17	
0V	0V	COM0	Y01	COM1	COM2	Y05	COM3	COM4	Y10	Y12	COM5	Y14	Y16	

■ Terminals of H_{3U}-1616MT/R-XP

⊕		0	0V	0V	S/S0	X00	X02	X04	X06	X10	X12	X14	X16	S/S1
L	N	0	24V	24V	S/S0	X01	X03	X05	X07	X11	X13	X15	X17	
Y00	0	Y02	0	Y04	0	Y06	0	Y10	Y12	0	Y14	Y16	0	
COM0	Y01	COM1	COM2	Y03	COM3	Y05	Y07	COM4	Y11	Y13	COM5	Y15	Y17	

■ Terminals of H_{3U}-0808PMRTA (selling stopped)

⊕		0	0V	S/S0	STOP0	LSPO	PG0-	S/S1	STOP1	LSP1	PG1-	S/S2	STOP2	LSP2	PG2-	S/S3	X01	X03	X05	X07	0
L	N	0	24V	START0	DOG0	LSN0	PG0+	START1	DOG1	LSN1	PG1+	START2	DOG2	LSN2	PG2+	X00	X02	X04	X06	0	
A0+	B0+	A1+	B1+	A2+	B2+	CLR0-	FP0-	RP0+	CLR1-	FP1-	RP1+	CLR2-	FP2-	RP2+	Y00	Y02	0	Y04	Y06	0	
A0-	B0-	A1-	B1-	A2-	B2-	CLR0-	FP0-	RP0-	CLR1-	FP1-	RP1-	CLR2-	FP2-	RP2-	COM0	Y01	Y03	COM1	Y05	Y07	

3.1.2 Functions of Terminals

Function	Terminals	Remarks
Power input	L, N, PE	To the two-phase AC power supply, 85-264 VAC, 220 VAC(Rated)
Power output	24V, 0V	Provide +24 VDC power supply externally. Usually, it provides power supply to DI/DO terminals and external sensors. Max. output current: 350 mA.
Normal transistor NPN output	Y00-Y03 on H _{3U} -0808PMRTA Y05-Y17 on H _{3U} -1616MR/T Y05-Y17 on H _{3U} -2416MR/T Y05-Y27 on H _{3U} -3624MR/T Y05-Y37 on H _{3U} -3232MR/T	Open-collector, optical coupling isolated. Circuit power voltage: 5 to 24 VDC. Max. output current: Resistive load: 2 A/1 point; 8 A/4 point common terminal; 8 A/8 point common terminal; Inductive load: 220 VAC, 80 VA; Lamp load: 1.5 W/24 VDC;
Hi-speed transistor NPN output	Y00-Y04 on H _{3U} -1616MR/T Y00-Y04 on H _{3U} -2416MR/T Y00-Y04 on H _{3U} -3624MR/T Y00-Y04 on H _{3U} -3232MR/T	Open-collector, optical coupling isolated. Circuit power voltage: 5 to 24 VDC. Max. output current: Resistive load: 0.5 A/point; 0.8A/4 points; 1.6A/8 points; Inductive load: 12 W/24 VDC; Lamp load: 1.5 W/24 VDC; Max. frequency: 200 kHz(each channel)
Relay output	Y04-Y07 on H _{3U} -0808PMRTA Y00-Y17 on H _{3U} -1616MR/T Y00-Y17 on H _{3U} -2416MR/T Y00-Y27 on H _{3U} -3624MR/T Y00-Y37 on H _{3U} -3232MR/T	Circuit power voltage: Below 250 VAC, 30 VDC Relay mechanical insulation ; Max. output current: Resistive load: 0.5 A/point; 0.8 A/4 points; 1.6 A/8 points; Inductive load: 12 W/24 VDC; Lamp load: 220 VAC, 100 W
Hi-speed differential output	(FPx+, FPx-) and (RPx+, RPx-) on H _{3U} -0808PMRTA	Max. frequency: 500 kHz Output voltage: ± 5 V (3.1 V when the load is 100 Ω)

Function	Terminals	Remarks
Normal transistor zero-clearing NPN output	CLR _x + and CLR _x - (common terminal) on H _{3U} -0808PMRTA	Open-collector, optical coupling isolated. Circuit power voltage: 5 to 24 VDC. Max. output current: Resistive load: 0.1 A ;
Normal input	X10-X17 on H _{3U} -1616MR/T X10-X27 on H _{3U} -2416MR/T X10-X43 on H _{3U} -3624MR/T X10-X37 on H _{3U} -3232MR/T STOP _x , LSP _x , LSN _x , DOG _x and START _x on H _{3U} -0808PMRTA	Detection voltage: 24 VDC1 Input resistance: 4.3 kΩ
Hi-speed input	X00-X07 on H _{3U} -1616MR/T X00-X07 on H _{3U} -2416MR/T X00-X07 on H _{3U} -3624MR/T X00-X07 on H _{3U} -3232MR/T	Detection voltage: 24 VDC1 Input resistance: 3.3 kΩ Max. frequency: 200 kHz
Hi-speed differential input	(A _x +, A _x -) and (B _x +, B _x -) on H _{3U} -0808PMRTA, (PG _x +, PG _x -) can serve as the leakage-type and source-type input terminal.	Input mode: Differential input, leakage/source type; Detection voltage: When the voltage is larger than 3V, it is ON; when the voltage is smaller than 2 V, it is OFF.



NOTE

15 V-24 V is ON. Voltage smaller than 5 V is OFF. The maximum value is 30 V. When all inputs are ON, the input voltage should not exceed 26.4 V.

3.2 Input Wiring

3.2.1 Normal Input Wiring

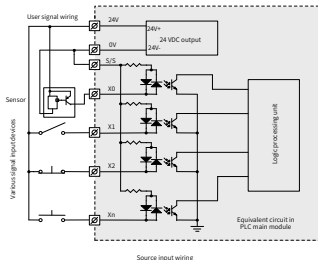
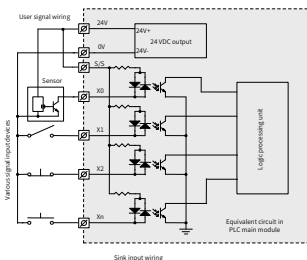

3.3 Output Wiring

3.3.1 Normal/Hi-speed Transistor Output Wiring

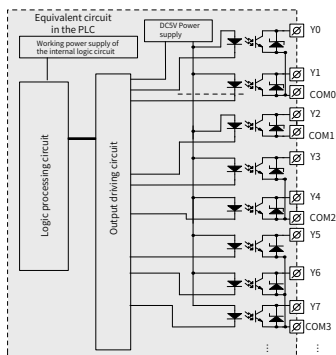

NOTE

The preceding figure takes terminal layout of H_{3U}-1616MT/R as an example. The wiring of other models is subject to the actual terminal layout

3.3.2 Wiring of Relay Outputs

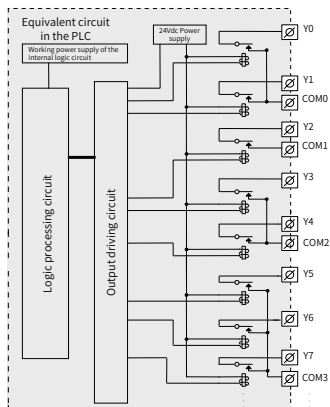



NOTE

The preceding figure takes terminal layout of H_{3U}-1616MT/R as an example. The wiring of other models is subject to the actual terminal layout

3.3.3 Wiring of Hi-Speed Differential Outputs

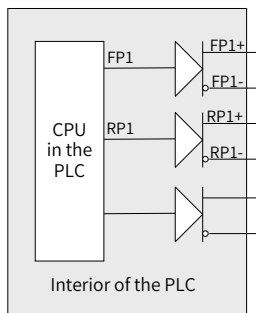

3.3.4 Wiring of Normal Transistor Zero-Clearing NPN Outputs

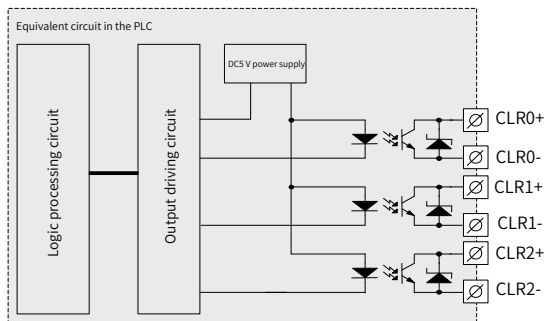

The normal transistor zero-clearing NPN output is the motion control pin of H_{3U}-0808PMRTA. It is designed for error resetting signal of servo. It is generally used for original point returning and electronic cam synchronization signal output.

3.4 Communication

3.4.1 Functions of Communication Terminals

The COM1 and CAN communication ports of H_{3U} need to be connected. The terminals are pluggable terminals. The definitions of the terminals are described in the following:

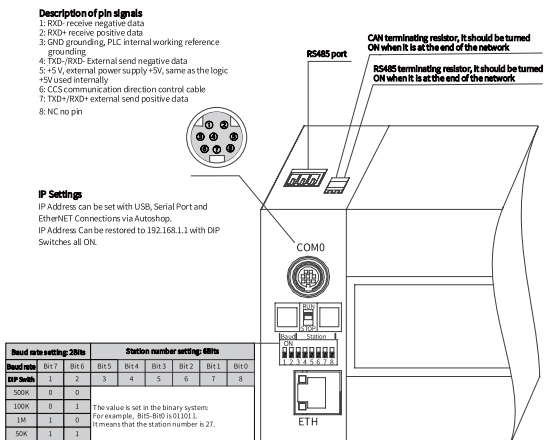
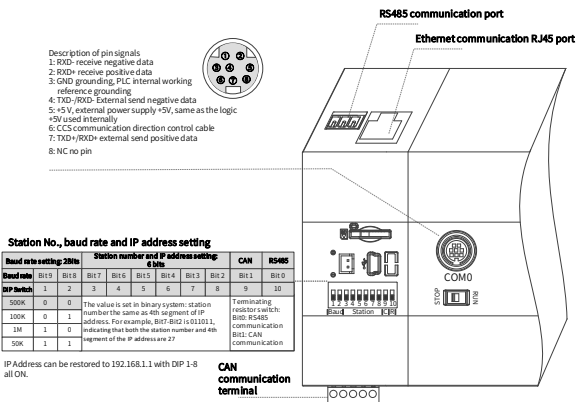

Name	Description	
+24V,CGND	CAN communication power supply, setting range is between 9-30 V	<p>The diagram shows the H3U terminal block with two main sections. The top section is labeled 'COM1' and contains three terminals: 'GND', '485+', and '485-'. The bottom section is labeled 'CAN communication port' and contains five terminals: '+24V', 'CAN-H', a shield symbol, 'CAN-L', and 'CGND'. The entire terminal block is labeled 'H3U'.</p>
CANL,CANH	CAN communication cable, the reference level is CGND. CGNDs must be connected to each other when there are multiple stations.	
	It is the shield layer, which should be connected according to the actual need.	
485+, 485-	It is used to connect the RS485 communication signal cable.	
GND	It is for the reference signal of the RS485 communication signal.	

3.4.2 Others

Communication configuration diagram of H_{3U}-3232MR/T, H_{3U}-3624MR/T, and H_{3U}-0808PMRTA (selling stopped)Communication configuration diagram of H_{3U}-1616MR/T-XP and H_{3U}-2416MR/T-XP

4 Quick Setup

4.1 Tools Requirements

Hardware Tool Kit	
<p>USB download cable for PLC (Inovance Part No.: H2U-USB-CAB)</p>	<div style="display: flex; justify-content: space-between;"> <div style="text-align: center;">  </div> <div style="text-align: right;"> <p>USB2.0 (Type-A) to Laptop</p> <p>USB2.0 (Mini-B) to PLC</p> </div> </div>
<p>Laptop for programming & download (Windows 7, Windows 8, Window 10)</p>	
Software Tool on Laptop	
<p>AutoShop (free installation, English, support Windows XP, Windows 7, Windows 8, Window 10)</p>	

4.2 Hardware Connection

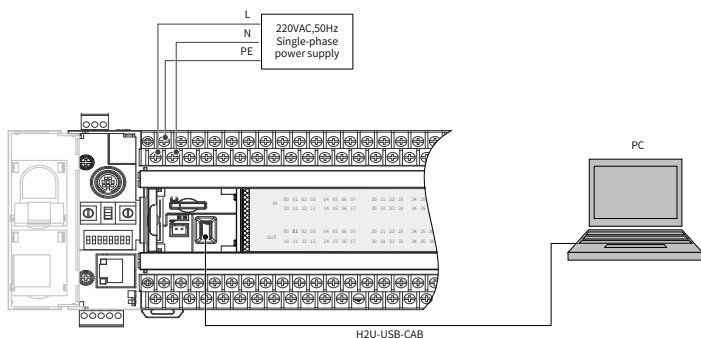

4.3 Installation of AutoShop

Step 1: Double click the  **AutoShop.msi** , the present version is V2.62 for English.

Step 2: Click "Next".

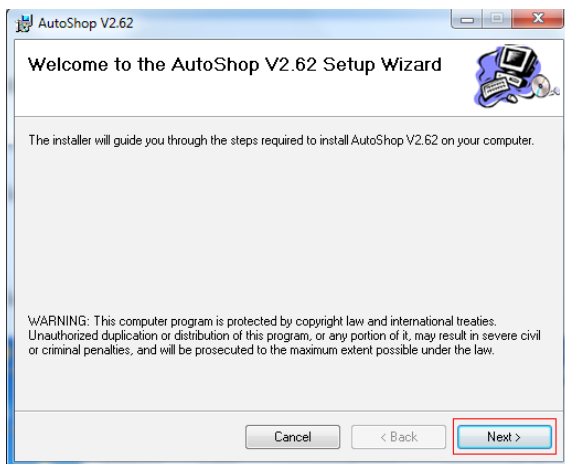

Step 3: Click "Next".

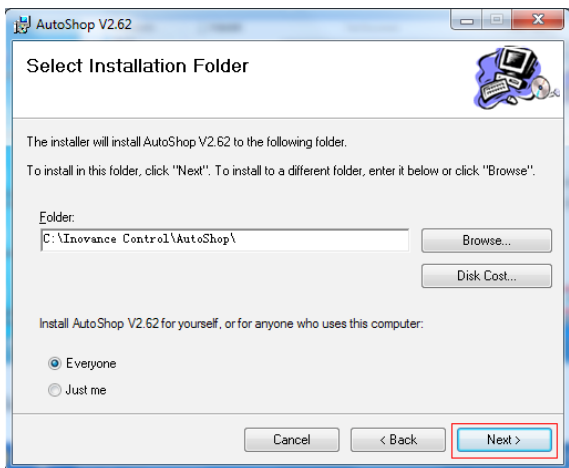

Step 4: Click "Next".

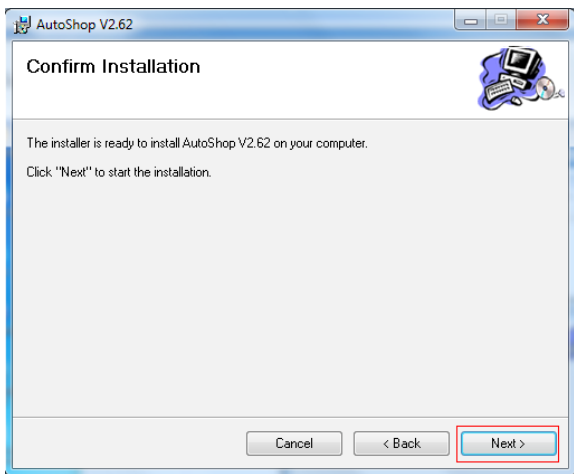

Step 5: Click "Install".

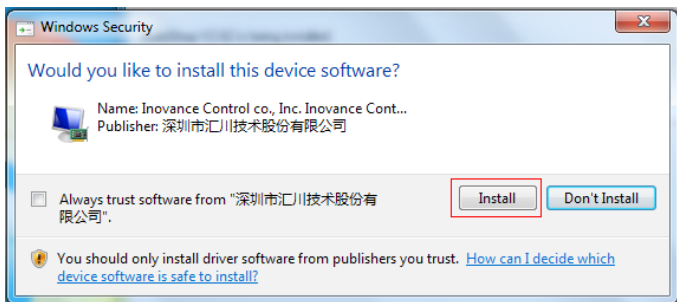

Step 6: Wait until the installation complete, click "Close".

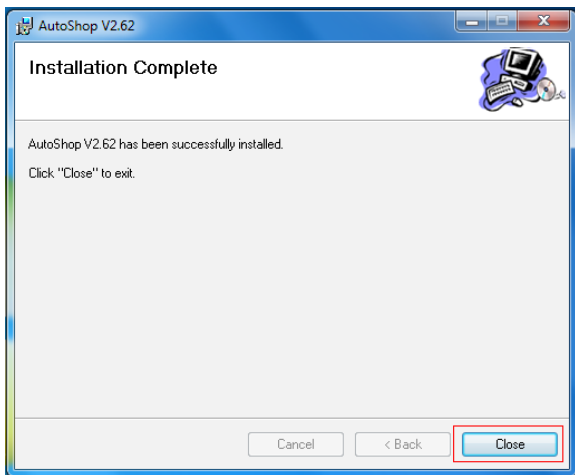

4.4 Program Download Procedure

Step 1:

- 1) Power on the PLC.
- 2) Double-click the "AutoShop".

3) Choose "File" > "New Project" from the main menu.

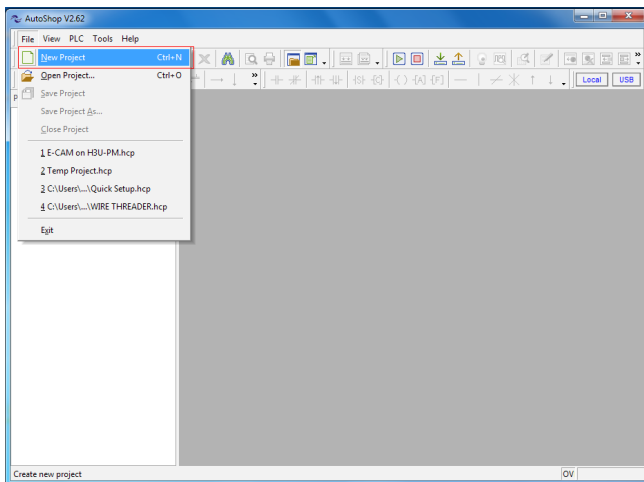

Step 2: Set as follows.

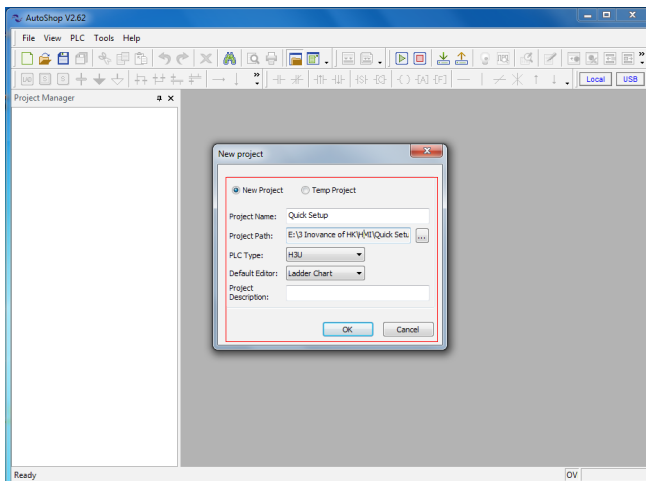

Step 3: Choose "Tools" > "Communication Setting" from the main menu.

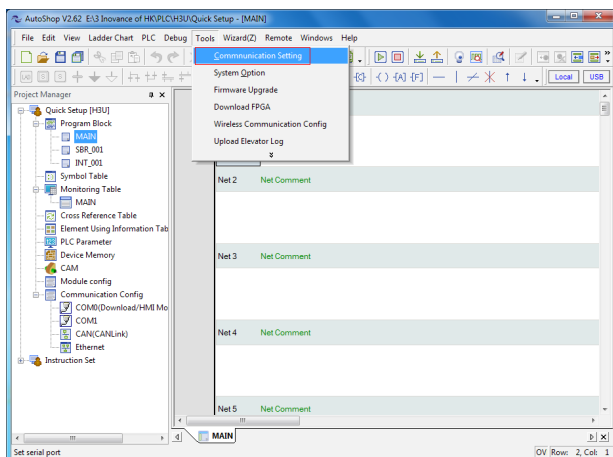

Step 4: Follow below steps.

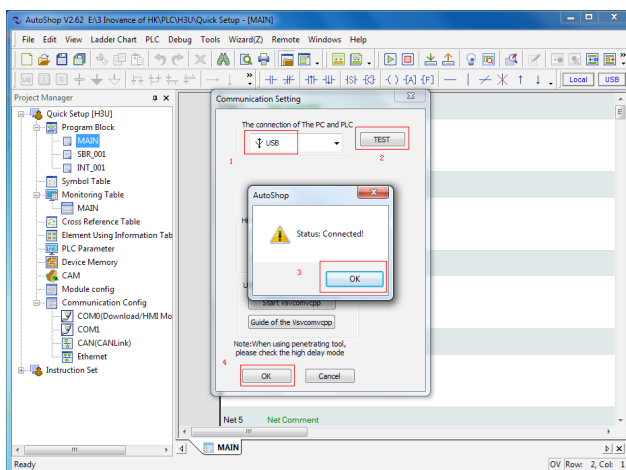

Step 5: Click "OK".

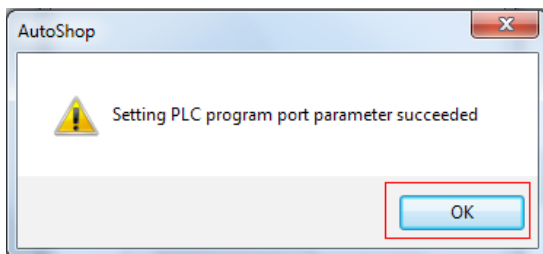

Step 6: Follow below steps.

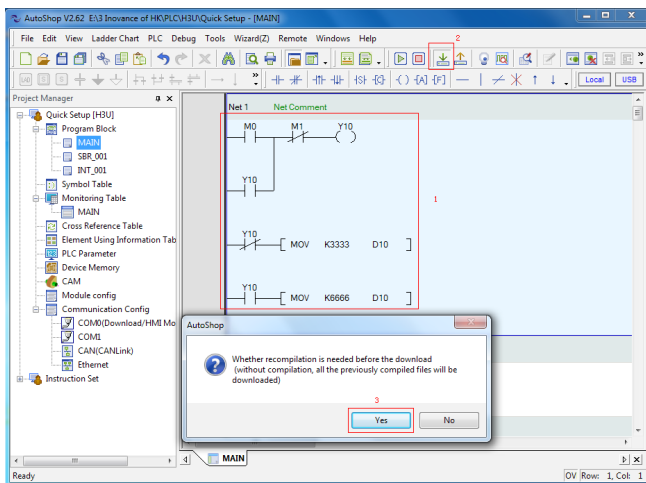

Step 7: Click "Download".

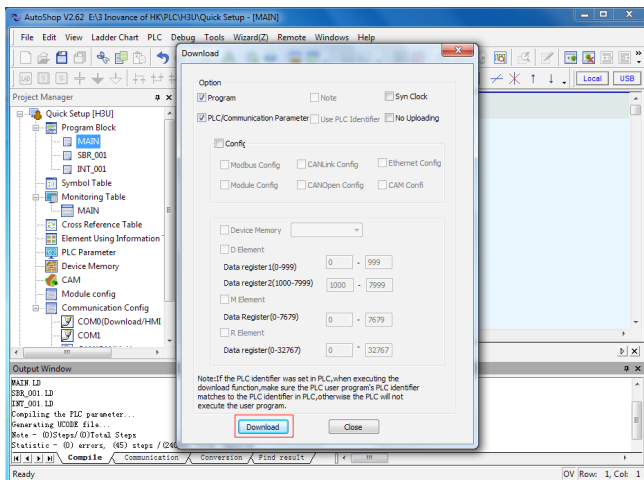

Step 8: The output window indicates the download executed.

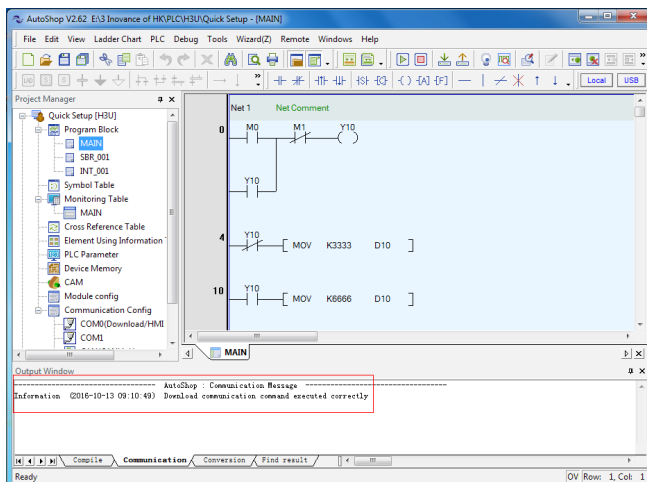

Step 9:

- 1) Switch to "RUN".
- 2) The RUN light is ON.

Step 10:

- 1) Click "monitor" widget to start monitoring program.
- 2) The lamps of PLC Status and Fault turn green.

The screenshot displays the AutoShop V2.62 software interface for monitoring a PLC program. The main window shows a ladder logic diagram with three rungs. Rung 0 contains a normally open contact M0 in series with a coil M1, which is connected to output Y10. Rung 4 contains a coil MOV K3333 D10, with Y10 as the input. Rung 10 contains a coil MOV K6666 D10, with Y10 as the input. The status bar at the bottom indicates 'PLC Status' is green, 'Fault' is green, and 'PLC Version:24301-0'. The 'Scan Period: 0.0 ms' and 'DV Row: 6, Cc' are also visible.

Output Window

Element	Addr	data type	display form	current value
Y0		16-bit int	Dec	
Y1		16-bit int	Dec	
Y2		16-bit int	Dec	
Y3		16-bit int	Dec	
Y4		16-bit int	Dec	
Y5		16-bit int	Dec	

Tips: Strongly recommend to set Display as below.

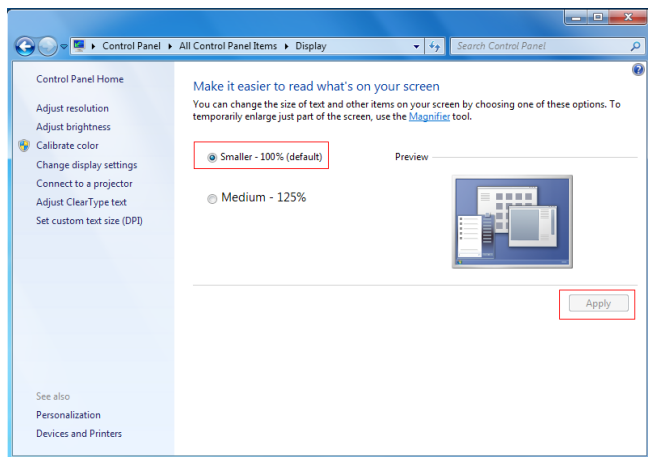

5 Troubleshooting

5.1 System Error Code D8060

Error Code	Content
D8060	I/O range or setting error
1000-1377	X input signal error, serial number error or exceeding limit
0000-0377	Y input signal error, serial number error or exceeding limit

5.2 System Error Code D8061

Error Code	Content
D8061	PC hardware error definition
6101	RAM error
6102	Operation loop error
6103	I/O hardware connection error
6104	External 24V power error
6105	System monitor error
6106	System flash read/write error
6107	System I/O setting error
6108	FPGA download error
6109	FPGA configuration data error in flash
6110	Ethernet hardware initialization failure
6111	Extension module configuration different from the actual
6112-6199	Reserved
16100-16199	Reserved
26100-26199	Reserved

5.3 System Error Code D8062

Error Code	Content
D8062	Communication error in control panel or program connection port
6200-6279 serial communication and configuration error codes	
6201	Receiving timeout
6202	CAN transmitting busy
6203	CAN receiving busy
6204	Data format incorrect
6205	Instruction incorrect
6206	Communication element exceeding range
6207	Communication port exceeding range or not existing
6208-6279	Reserved
6280-6299	CAN communication configuration error code
16200-16219 Ethernet configuration error code	
16200	Reserved
16201	Ethernet configuration: function codes not supported
16202	Ethernet configuration: register start address incorrect or start address plus number of registers incorrect
16203	Ethernet configuration: number of registers too large
16204	Ethernet configuration: reading/writing register failed.
16205	Ethernet configuration: ACK signal
16206	Ethernet configuration: slave busy
16207	Ethernet configuration: station number incorrect
16208	Ethernet configuration: memory check error
16209	Reserved
16210	Ethernet configuration: gateway path error

Error Code	Content
16211	Ethernet configuration: destination gateway path error
16212-16215	Reserved
16216	Ethernet configuration: IP address illegal
16217-16219	Reserved
16220-16239	Extension module configuration error code
16240-16259	USB communication configuration error code
16260-16279 motion control configuration error code	
16260	Mechanical unit setting value incorrect
16261	Electronic gear ratio setting value incorrect
16262	Cam table not configured in software being used
16263	No external input master axis selected for electronic cam
16264	Electronic cam slave axis speed exceeding maximum output speed allowed
16265	Synchronization lower limit larger than upper limit
16266	Master axis setting exceeding range
16267	Delayed startup pulses setting incorrect
16268	Instruction written in cam key point, value of key point illegal
16269	Cam encrypted, not allowing instruction to read key point data
16270	Electronic cam slave axis zooming incorrect
16271	Electronic cam configuration unit incorrect
16272	Failure in modifying electronic cam during running
16273	Electronic cam modification instruction used repeatedly
16274-16279	Reserved
16280-16299	Reserved
26200-26299	Reserved

5.4 System Error Code D8063

Error Code	Content
D8063	Communication error
6300-6379 COM0 to COMx serial communication error code	
6301	Odd/Even check error, overflow error, frame error
6302	Communication character incorrect
6303	Communication data sum inconsistent
6304	Data format incorrect
6305	Instruction incorrect
6306	Monitor timer timeout
6307	Reserved
6308	Reserved
6309	Reserved
6310	Reserved
6311	Reserved
6312	Parallel control (1:1) protocol character incorrect
6313	Parallel control (1:1) protocol sum incorrect
6314	Parallel control (1:1) protocol format incorrect
6315	Parallel control (1:1) protocol communication timeout
6316-6329	Reserved
6330+10*X	Modbus slave address setting incorrect, address larger than 247
6331+10*X	Data frame length incorrect, returned frame length not meeting requirement, or smaller than 5
6332+10*X	Address incorrect, standard error frame; transmit/receive addresses inconsistent
6333+10*X	CRC check error
6334+10*X	Instruction code not supported, standard error frame; transmit/receive instructions inconsistent; instruction not supported
6335+10*X	Receiving timeout

Error Code	Content
6336+10*X	Data error, standard error frame
6337+10*X	Reserved
6338+10*X	Frame error, standard error frame
6339+10*X	Serial protocol error, not configuring corresponding protocol when using Modbus or RS instruction
6380– 6399: CAN communication error code	
6380	Transmitting timeout
6381	Receiving timeout
6382	CAN transmitting busy
6383	CAN receiving busy
6384-6399	Reserved
16300-16319 Ethernet communication error code	
16300-16311	Reserved
16312	Protocol designator error Modbus protocol
16313	Frame length error
16314	Frame timeout error
16315	Frame not recognized by slave (only for master)
16316	IP address illegal
16317-16319	Reserved
16320-16339	Extension module communication error code
16340-16359	USB communication error code
16360-16379	Control panel and interface communication error code
16380-16399	Reserved
26300-26399	Reserved

5.5 System Error Code D8064

Error Code	Content
D8064	System parameter setting incorrect
6401	Program and parameter inconsistent
6402	Program capacity setting incorrect
6403	Changeable power failure retentive area of soft element setting incorrect
6404	Parameter area setting incorrect
6405	Program area setting incorrect
6406-6424	Reserved
6425	User program check error, download data incorrect
6426	User program, including motion control subroutine program, incomplete
6427	PLC designator and user program designator not matching
6428	Factory commissioning error
6429-6452	Reserved
6453-6465	Changeable power failure retentive area of soft element setting incorrect
6466-6499	Reserved
16400-16499	Reserved
26400-26499	Reserved

5.6 System Error Code D8065

Error Code	Content
D8065	User program grammar error
6501	Reserved
6502	Reserved
6503	Instruction parameter error
6504	Label definition repeated
6505	Reserved
6506	Non-defined instruction used
6507	Label P definition incorrect
6508	Label I definition incorrect
6509	Reserved
6510	Reserved
6511	High-speed counter and interrupter using same input
6512-6599	Reserved
16500-16599	Reserved
26500-26599	Reserved

5.7 System Error Code D8066

Error Code	Content
D8066	User program logic loop error
6601-6604	Reserved
6605	Incorrect instruction used in STL
6606	Incorrect instruction in incorrect position
6607	FOR-NEXT operation error
6608	MC-MCR operation error
6609-6617	Reserved
6618	Instructions allowed only in main program exist in other areas
6619	Instructions cannot be used in FOR_NEXT
6620	Nesting level in FOR_NEXT exceeded
6621	FOR_NEXT quantitative relationship incorrect
6622	No NEXT instruction
6623	No MC instruction
6624	No MCR instruction
6625	STL used for above consecutive nine times
6626	Certain instructions cannot be used in STL-RET
6627	No RET instruction
6628	Instructions useless in main program
6629	No P or I
6630	No SRET or IRET instruction
6631	SRET cannot be used in the position
6632	FEND cannot be used in the position
6633-6699	Reserved
16600-16699	Reserved
26600-26699	Reserved

5.8 System Error Code D8067

Error Code	Content
D8067	Instruction parameter & running parameter incorrect
6701	CALL&CJ invoking error
6702	CALL running times larger than 6
6703	Reserved
6704	Communication parameter area setting incorrect
6705	Element not existing or exceeding range
6706	Data incorrect or exceeding range
6707	FOR&NEXT, MC, MCR, STL, subroutine program, interruption program relationship not clear
6708	FROM or TO instruction incorrect
6709	IRET, SRET, FOR-NEXT relationship not in a match
6710	Local variable used in main program
6711	Soft element using in instruction repeated or conflict
6712	Non-defined interrupt used in system
6713-6719	Reserved
6720	CALL instruction SRET not in a match
6721	Parameter incorrect in subroutine program with parameters
6722	Manipulator instruction port function conflict
6723-6729	Reserved
6730	Sampling time TS < 0
6731	Reserved
6732	Input filter constant object abnormal
6733	Input proportional coefficient abnormal
6734	Integral time abnormal
6735	Differential gain abnormal
6736	Differential time abnormal
6737	Reserved

Error Code	Content
6738	Reserved
6739	Reserved
6740	Sampling time abnormal
6741	Reserved
6742	Measured variable overflow
6743	Offset abnormal
6744	Integral term abnormal
6745	Differential value overflow due to differential restrictor
6746	Differential term abnormal
6747	PID result abnormal
6748-6759	Reserved
6760-6799 High-speed input/output error code	
6760	Number of high-speed input instruction running entries exceeding limit
6761	High-speed input C counter multiplexing error
6762	High-speed input instruction port repeated or conflict
6763	High-speed input instruction element exceeding range
6764	High-speed input instruction data exceeding range
6765	High-speed output instruction element exceeding range
6766	High-speed output instruction data exceeding range
6767	Conflict in comparison objects setting of high-speed interruption comparison instruction
6768	Reserved
6769	Reserved
6770	High-speed output instruction port repeated or conflict
6771	High-speed output instruction signal incorrect
6772	Motion control subroutine program instruction incorrect, compiling incorrect or not existing

Error Code	Content
6773	Motion control subroutine program invoking error
6774	Reserved
6775	Motion control subroutine program instruction element exceeding range, function word not matching or existing
6776	Motion control subroutine program data incorrect or exceeding range
6777	High-speed interpolation instruction arc length too small
6778	High-speed interpolation instruction arc parameter incorrect (center or circle setting incorrect, radius too long), resulting in arc generating failure
6779	Helical curve 3rd axis pulses of high-speed output interpolation instruction exceeding range
6780-6799	Reserved
16700-16799	Reserved
26700-26799	Reserved

Revision History

Date	Version	Change Description
Jan. 2017	A00	First issue. Firmware version: ◆ Standard models = 24306-0000 ◆ H _{3U} -0808PMRTA = 25305-0000
May 2017	A01	◆ Modified the 24 V input wiring diagrams.
Jun. 2018	A02	◆ Add descriptions of H _{3U} -2416MT/MR-XP and H _{3U} -3624MT/MR. ◆ Correct the error of COM port in diagrams.
Nov.2020	A03	◆ Add memo information: H _{3U} -0808PMRTA is not for sale anymore.
Apr.2020	A04	◆ Removed model number description for unavailable models.
Oct.2020	A05	◆ Added a note to notify the user that the PM products are discontinued.

Shenzhen Inovance Technology Co., Ltd.

Add.: Building E, Hongwei Industry Park, Liuxian Road, Baocheng No. 70 Zone, Bao'an District, Shenzhen

Tel: +86-755-2979 9595

Fax: +86-755-2961 9897

<http://www.inovance.com>

Suzhou Inovance Technology Co., Ltd.

Add.: No. 16 Youxiang Road, Yuexi Town, Wuzhong District, Suzhou 215104, P.R. China

Tel: +86-512-6637 6666

Fax: +86-512-6285 6720

<http://www.inovance.com>



19010494A05

Copyright © Shenzhen Inovance Technology Co., Ltd.